



*Instruction Manual*

**DVD-V540**

**DVD-V440**

**DVD-V340**

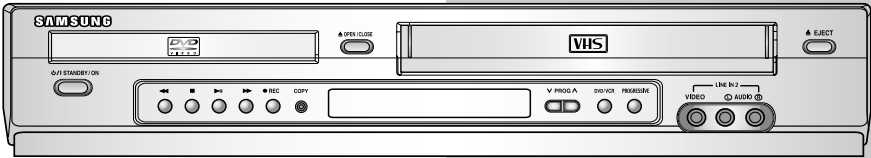

# Remote Control Overview

(DVD-V540)

(DVD-V440/V340)

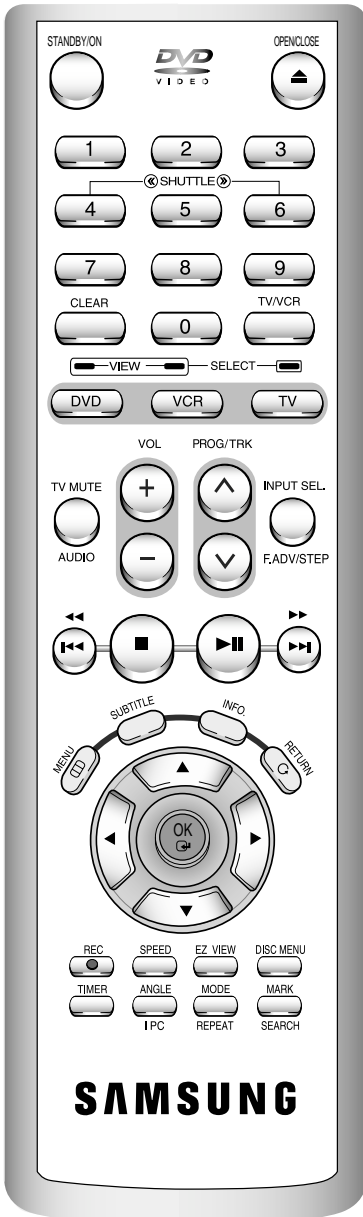

# Contents

◆ <b>Foreword</b>	
Safety Instructions . . . . .	3
Disc Type and Characteristics . . . . .	4
◆ <b>DVD-VCR Overviews</b>	
Front View of the DVD-VCR . . . . .	5
Rear View of the DVD-VCR . . . . .	6
Accessories . . . . .	6
Display Indicators . . . . .	7
◆ <b>Connecting Your DVD-VCR</b>	
Inserting Batteries in the Remote Control . . . . .	7
Connecting DVD-VCR to the TV using the Coaxial Cable . . . . .	7
Connecting DVD-VCR to the TV using the RCA Cable . . . . .	8
Connecting DVD-VCR to a Satellite Receiver or Other Equipment . . . . .	8
Plug & Auto Set up . . . . .	9
Tuning Your Television for the DVD-VCR . . . . .	9
Deck Control Keys . . . . .	10
Copying from DVD to VCR . . . . .	10
Setting the Date and Time . . . . .	11
Setting the Menu Language . . . . .	11
◆ <b>Setting Up Your DVD-VCR</b>	
Presetting the Stations Automatically . . . . .	12
Presetting the Stations Manually . . . . .	13
Clearing a Preset Station . . . . .	14
Changing the Preset Station Table . . . . .	14
Selecting the RF OUT Sound Mode (B/G-D/K) . . . . .	15
Setting the DVD-VCR Output Channel . . . . .	15
Selecting the Colour Mode . . . . .	16
NICAM *(DVD-V540/DVD-V440) . . . . .	16
Intelligent Picture Control . . . . .	17
Auto Power off . . . . .	17
Screen Messages . . . . .	17
Selecting the Cassette Type . . . . .	18
Repeat Play . . . . .	18
◆ <b>Recording Television Broadcasts</b>	
Selecting the Recording Speed . . . . .	18
S-VHS Play . . . . .	18
Recording a Programme Immediately . . . . .	19
Protecting a Recorded Cassette . . . . .	19
Recording a Programme with Automatic Stop . . . . .	19
Using the Timer Programming Feature . . . . .	20
Checking a Preset Recording . . . . .	20
Cancelling a Preset Recording . . . . .	21
◆ <b>Playing Back</b>	
Playing a Cassette . . . . .	21
Adjusting Picture Alignment Manually . . . . .	21
Selecting the Audio Output Mode . . . . .	21
Playing a Cassette in Slow Motion . . . . .	22
Playing a Sequence Frame by Frame . . . . .	22
Playing a Sequence at Variable Speeds . . . . .	22
Searching for a Specific Sequence . . . . .	22
Using the Tape Counter . . . . .	23
Using the Assemble Edit Function . . . . .	24
Connecting an RCA Audio/Video Input Cable . . . . .	24
Recording from Another VCR or Camcorder . . . . .	25
Using the TV Buttons on the Remote Control *(DVD-V540 Only) . . . . .	25
◆ <b>DVD Functions</b>	
Choosing a Connection . . . . .	26
Setting Up the Language Features . . . . .	26
Setting Up the Audio Options . . . . .	28
Setting Up the Display Options . . . . .	29
Setting Up the Parental Control . . . . .	30
A/V Receiver Connections . . . . .	31
Special Playback Features . . . . .	31
Component Connections (for DVD) *(DVD-V540/DVD-V440) . . . . .	32
Adjusting the Aspect Ratio (EZ View) . . . . .	33
Using the Display Function . . . . .	34
Changing the Camera Angle . . . . .	35
Selecting the Subtitle Language . . . . .	35
Repeat Play . . . . .	36
Selecting the Audio Language . . . . .	36
Using the Mark Function . . . . .	37
MP3/WMA Play . . . . .	37
Program Play & Random Play . . . . .	39
Picture CD Playback . . . . .	39
DivX/Xvid/MPEG4 Special Playback Features *(DVD-V540/DVD-V440) . . . . .	41
DivX/Xvid/MPEG4 Playback *(DVD-V540/DVD-V440) . . . . .	42
◆ <b>Solving Problems</b>	
Technical Specifications . . . . .	43
Problems and Solutions (VCR) . . . . .	44
Troubleshooting Guide (DVD) . . . . .	45

# Safety Instructions

The following illustrations represent precautions.



**The lightning bolt is a warning sign alerting you to dangerous voltage inside the product.**

DO NOT OPEN THE DVD-VCR. Refer to service personnel.

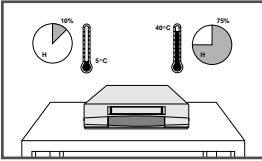

Do NOT expose the DVD-VCR to extreme temperature conditions (below 5°C and above 40°C) or to extreme humidity conditions (less than 10% and more than 75%).

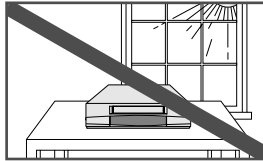

Do NOT expose the DVD-VCR to direct sunlight.

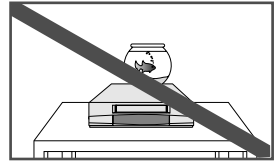

Do NOT expose the DVD-VCR to any liquids.

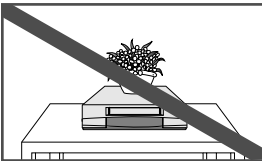

Do NOT place any objects on the DVD-VCR or remote control.

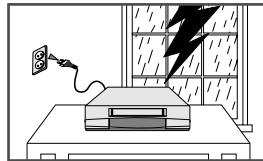

During a storm and/or lightning, unplug the DVD-VCR from the mains socket and aerial.

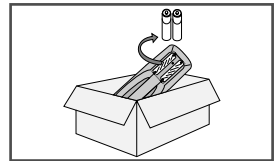

If the remote control is not used for a long period of time, remove the batteries and store it in a cool, dry place.



THIS DEVICE IS NOT FOR USE IN INDUSTRIAL ENVIRONMENTS

This product incorporates copyright protection technology that is protected by method claims of certain U.S. patents and other intellectual property rights owned by Macrovision Corporation and other rights owners.

Use of this copyright protection technology must be authorized by Macrovision Corporation, and is intended for home and other limited viewing uses only unless otherwise authorized by Macrovision Corporation. Reverse engineering or disassembly is prohibited.

## Disc Type and Characteristics

This DVD player is capable of playing the following types of discs with the corresponding logos :





Disc Types (Logos)	Recording Types	Disc Size	Max. Playing Time	Characteristics
<b>DVD</b> 	Audio + Video	12 Cm	Single-sided 240 min. Double-sided 480 min.	<ul style="list-style-type: none"> <li>DVD contains excellent sound and video due to Dolby Digital and MPEG-2 system.</li> <li>Various screen and audio functions can be easily selected through the on-screen menu.</li> </ul>
		8 Cm	Single-sided 80 min. Double-sided 160 min.	
<b>VIDEO-CD</b> 	Audio + Video	12 Cm	74 min.	<ul style="list-style-type: none"> <li>Video with CD sound, VHS quality &amp; MPEG-1 compression technology.</li> </ul>
		8 Cm	20 min.	
<b>AUDIO-CD</b> 	Audio	12 Cm	74 min.	<ul style="list-style-type: none"> <li>An LP is recorded as an analog signal with more distortion. CD is recorded as a Digital Signal with better audio quality, less distortion and less deterioration of audio quality over time.</li> </ul>
		8 Cm	20 min.	

\* DO NOT play CD-ROM, CD-I and DVD-ROM in this player!

(CDGs play audio only, not graphics.)

\* It may not be to play CD-R,CD-RW and DVD-R in all cases due to the type of disc or condition of the recording.

### Disc Markings

	• Play Region Number
<b>PAL</b>	• PAL colour system in Australia, Newzealand, etc.
<b>NTSC</b>	• NTSC broadcast system in U.S.A, Canada, Korea, Japan, etc.
	• Dolby Digital disc
<b>STEREO</b>	• Stereo disc
<b>DIGITAL SOUND</b>	• Digital Audio disc
	• DTS disc
	• Disc contains a Divx software product

### Play Region Number

Both the DVD player and the discs are coded by region. These regional codes must match in order for the disc to play. If the codes do not match, the disc will not play.

**The Region Number for this player is described on the rear panel of the player.**

## Front View of the DVD-VCR

### (DVD-V540)

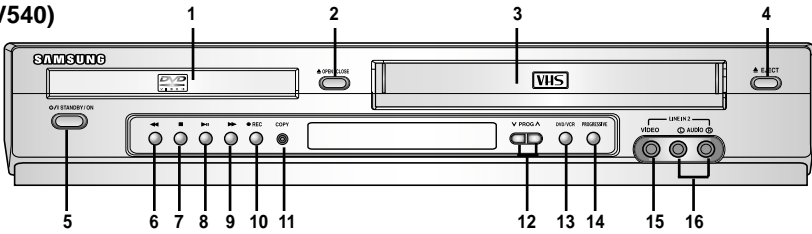

- |                              |                              |                                   |
|------------------------------|------------------------------|-----------------------------------|
| 1 DVD DECK                   | 7 STOP BUTTON                | 13 DVD / VCR SELECT BUTTON        |
| 2 OPEN/CLOSE BUTTON          | 8 PLAY/STILL BUTTON          | 14 PROGRESSIVE BUTTON             |
| 3 VIDEO CASSETTE COMPARTMENT | 9 F.F / SKIP NEXT BUTTON     | 15 LINE IN2 VIDEO INPUT JACK      |
| 4 EJECT BUTTON               | 10 RECORD BUTTON             | 16 LINE IN2 AUDIO L, R INPUT JACK |
| 5 STANDBY/ON BUTTON          | 11 COPY BUTTON               |                                   |
| 6 REW/SKIP BACK BUTTON       | 12 PROGRAME SELECTION BUTTON |                                   |

### (DVD-V440)

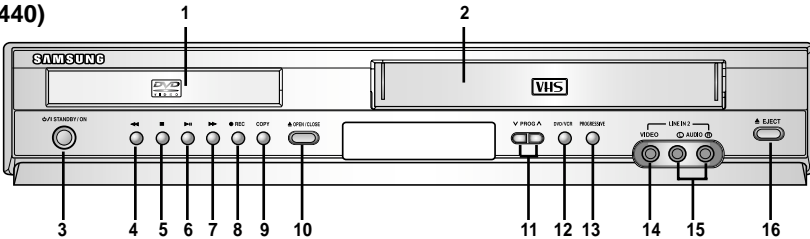

- |                              |                              |                                   |
|------------------------------|------------------------------|-----------------------------------|
| 1 DVD DECK                   | 7 F.F / SKIP NEXT BUTTON     | 13 PROGRESSIVE BUTTON             |
| 2 VIDEO CASSETTE COMPARTMENT | 8 RECORD BUTTON              | 14 LINE IN2 VIDEO INPUT JACK      |
| 3 STANDBY/ON BUTTON          | 9 COPY BUTTON                | 15 LINE IN2 AUDIO L, R INPUT JACK |
| 4 REW/SKIP BACK BUTTON       | 10 OPEN/CLOSE BUTTON         | 16 EJECT BUTTON                   |
| 5 STOP BUTTON                | 11 PROGRAME SELECTION BUTTON |                                   |
| 6 PLAY/STILL BUTTON          | 12 DVD / VCR SELECT BUTTON   |                                   |

### (DVD-V340)

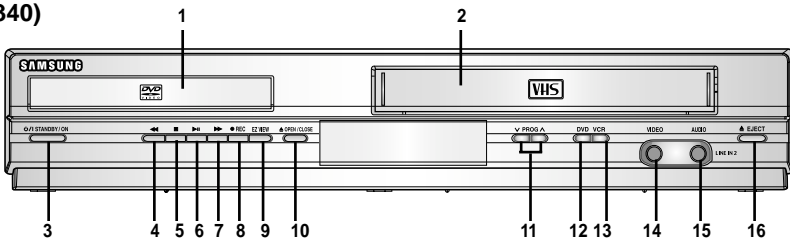

- |                              |                              |                              |
|------------------------------|------------------------------|------------------------------|
| 1 DVD DECK                   | 7 F.F / SKIP NEXT BUTTON     | 13 VCR SELECT BUTTON         |
| 2 VIDEO CASSETTE COMPARTMENT | 8 RECORD BUTTON              | 14 LINE IN2 VIDEO INPUT JACK |
| 3 STANDBY/ON BUTTON          | 9 EZ VIEW BUTTON             | 15 LINE IN2 AUDIO INPUT JACK |
| 4 REW/SKIP BACK BUTTON       | 10 OPEN/CLOSE BUTTON         | 16 EJECT BUTTON              |
| 5 STOP BUTTON                | 11 PROGRAME SELECTION BUTTON |                              |
| 6 PLAY/STILL BUTTON          | 12 DVD SELECT BUTTON         |                              |

## Rear View of the DVD-VCR

(DVD-V540/DVD-V440)

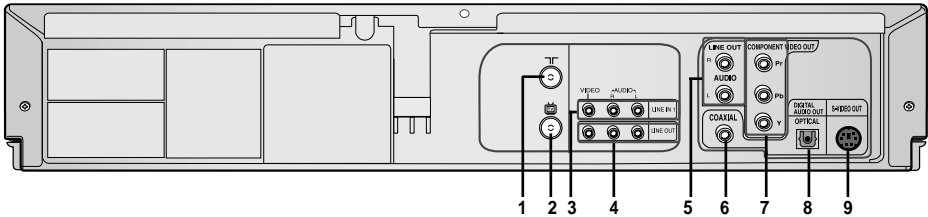

- |   |                            |   |  |   |                                       |
|---|----------------------------|---|--|---|---------------------------------------|
| 1 | RF ANTENNA INPUT           | 5 | AUDIO LINE OUT TO TV<br>(S-VIDEO OR COMPONENT) | 7 | COMPONENT VIDEO OUT                   |
| 2 | RF OUT TO TV               | 6 | DIGITAL AUDIO OUT SOCKET<br>(COAXIAL)          | 8 | DIGITAL AUDIO OUT SOCKET<br>(OPTICAL) |
| 3 | LINE IN 1                  | 9 | S-VIDEO OUT JACK                               |   |                                       |
| 4 | LINE OUT TO TV (COMPOSITE) |   |  |   |                                       |

(DVD-V340)

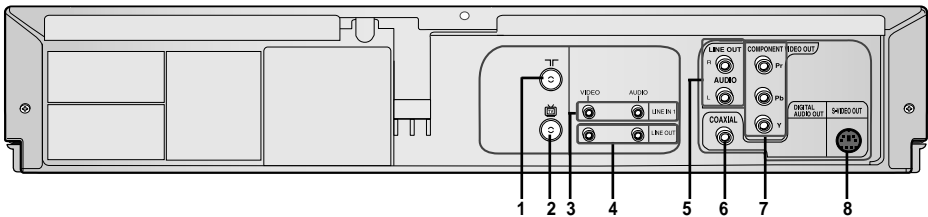

- |   |                            |   |  |   |                     |
|---|----------------------------|---|--|---|---------------------|
| 1 | RF ANTENNA INPUT           | 5 | AUDIO LINE OUT TO TV<br>(S-VIDEO OR COMPONENT) | 7 | COMPONENT VIDEO OUT |
| 2 | RF OUT TO TV               | 6 | DIGITAL AUDIO OUT SOCKET<br>(COAXIAL)          | 8 | S-VIDEO OUT JACK    |
| 3 | LINE IN 1                  |   |  |   |                     |
| 4 | LINE OUT TO TV (COMPOSITE) |   |  |   |                     |

## Accessories

You have just purchased a SAMSUNG Video Cassette Recorder (DVD-VCR).  
Together with your DVD-VCR, you will find the following accessories in the box.

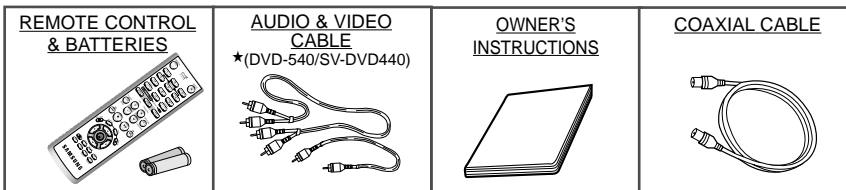

## Display Indicators

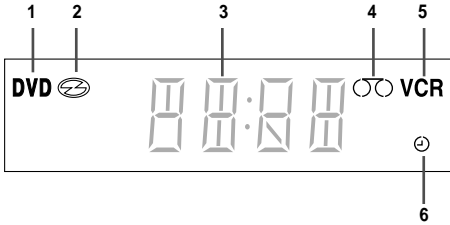

- 1 The DVD Deck is active
- 2 A DVD, CD, VCD, or SVCD is loaded
- 3 The time, counter position, time remaining or current deck status is displayed
- 4 VHS tape is inserted
- 5 The VCR Deck is active
- 6 A Timer Recording is programmed or in progress.

## Inserting Batteries in the Remote Control

You must insert or replace the batteries in the remote control when you:

- ◆ Purchase the DVD-VCR
- ◆ Find that the remote control is no longer working correctly

- 1 Push the tab in the direction of the arrow to release the battery compartment cover on the rear of the remote control.
- 2 Insert two AAA, RO3 or equivalent batteries, taking care to respect the polarities:
  - ◆ + on the battery with + on the remote control
  - ◆ - on the battery with - on the remote control
- 3 Replace the cover by aligning it with the base of the remote control and pushing it back into place.

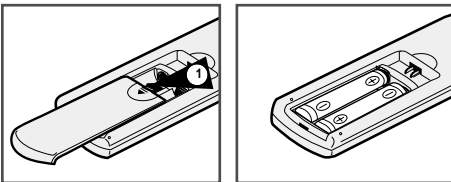



➤ Do not mix different battery types (manganese and alkaline for example).

## Connecting DVD-VCR to the TV using the Coaxial Cable

To receive television programmes a signal must be received from one of the following sources:

- ◆ An outdoor aerial
- ◆ An indoor aerial
- ◆ A cable television network
- ◆ A satellite receiver

✎ Make sure that both the television and the DVD-VCR are switched off before connecting the cables.

- 1 Remove the aerial or network input cable from the television.
- 2 Connect this cable to the 75Ω coaxial socket marked  on the rear of your DVD-VCR.
- 3 Plug the coaxial cable supplied into the  socket on your DVD-VCR.
- 4 Plug the other end of the coaxial cable into the connector previously used for the aerial on the television.
- 5 To obtain better quality pictures and sound on your television, you can also connect your DVD-VCR to the television via the RCA cable (see next page) if your television is equipped with this type of connection.

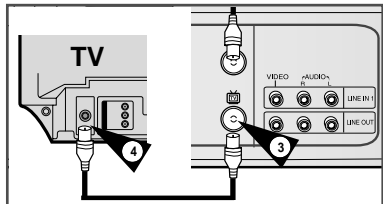
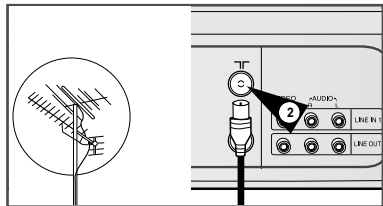



## Connecting DVD-VCR to the TV using the RCA Cable

You can connect your DVD-VCR to the television using the RCA cable if the appropriate input is available on the television. You thus:

- ◆ Obtain better quality sound and pictures
- ◆ Simplify the setting up procedure of your DVD-VCR

☞ Regardless of the type of connection chosen, you must always connect the coaxial cable supplied. Otherwise, no picture will be visible on the screen when the DVD-VCR is switched off.

☞ Make sure that both the television and the DVD-VCR are switched off before connecting the cables.

- 1 Connect the coaxial cable as indicated on page 7.
- 2 Connect one end of the RCA Audio/Video cable to the Video output and Audio L, R output socket on the rear of the DVD-VCR.
- 3 Plug the other end into the appropriate connector on the television.

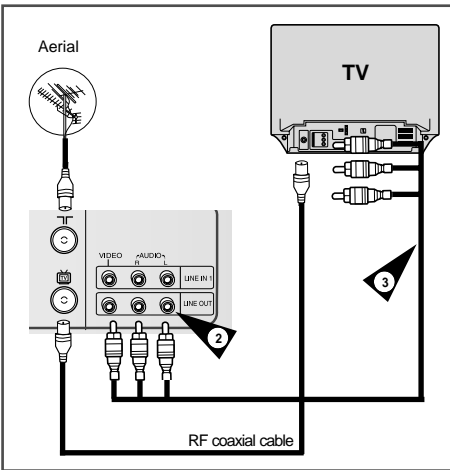

## Connecting DVD-VCR to a Satellite Receiver or Other Equipment

You can connect other audio and/or video equipment to your DVD-VCR in different ways. The following illustrations give a few examples of the connection possibilities.

➤ The RCA input/output connectors on the rear of the DVD-VCR are used for equipment, such as camcorders, VCRs or sound systems.

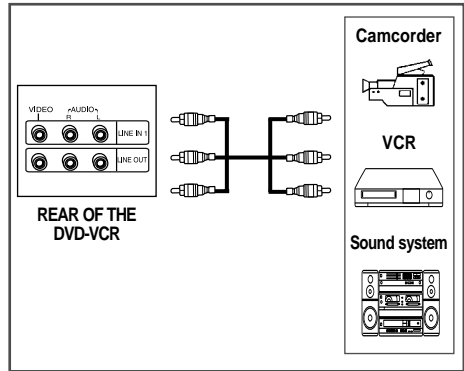

## Plug & Auto Set up

Your DVD-VCR will automatically set itself up when it is plugged into the mains for the first time. TV stations will be stored in memory. The process takes a few minutes. Your DVD-VCR will then be ready for use.

- 1 Connect the coaxial cable as indicated on page 7. (Connecting Your DVD-VCR to the TV Using the Coaxial Cable)
- 2 Plug the DVD-VCR into the mains.  
Result: The **Language Set** menu is displayed.
- 3 Select the required language by pressing the ▲ or ▼ buttons.
- 4 Press OK to store the language selected.  
Result: A message appears.
- 5 Press OK to start the auto scanning.
  - ◆ The number of stations automatically stored by the VCR depends on the number of stations that it has found.

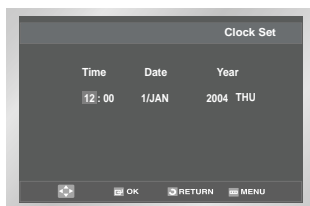
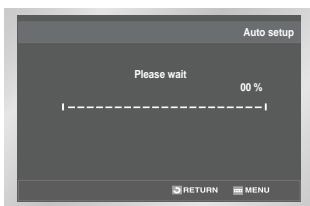

- *Auto preset can be performed by pressing ■ on the VCR continuously for 5 seconds or more with no tape inserted.*

## Tuning Your Television for the DVD-VCR

You must tune your television for the DVD-VCR only if you are not using a RCA cable

- *To view pictures from your DVD-VCR when a RCA cable is used, the television must be set to the audio/video mode (AV).*
- 1 Switch on the television.
  - 2 Switch on the DVD-VCR by pressing STANDBY/ON on the front of the DVD-VCR or STANDBY/ON on the remote control.
  - 3 Select a programme position on the television to be reserved for use with your DVD-VCR.
  - 4 Insert the video cassette in the DVD-VCR. Check that the DVD-VCR starts reading the cassette; if not, press ►|| button.
  - 5 Start a scan on your television or set the television to UHF channel 36.
  - 6 Fine tune the television until the pictures and sound are obtained clearly.
  - 7 If you cannot find the pictures and sound, or there is interference from nearby channels, it may be necessary to change the setting of the DVD-VCR output channel (see Setting the DVD-VCR Output Channel on page 14 and Problems and Solutions on page 44).
  - 8 When the picture and sound are perfectly clear, store this channel at the desired programme position on the television.  
Result: That programme is now reserved for use with your DVD-VCR.

## Deck Control Keys

The DVD-VCR uses one set of controls to operate both decks. The following keys are helpful in successfully controlling each deck.

### 1 STANDBY/ON Button

Press the STANDBY/ON button on the remote control or front panel to turn on the DVD-VCR.

### 2 DVD Button

Press the DVD button on the remote control when you want to control the DVD deck.

- ◆ The DVD indicator will light on the Front Panel Display to show that the DVD deck is selected.

### 3 VCR Button

Press the VCR button on remote control when you want to control the VCR deck.

- ◆ The VCR indicator will light on the Front Panel Display to show that VHS deck is selected.

### 4 INPUT SEL. Button

Press the INPUT SEL. button repeatedly to cycle through all of your input sources, including the Tuner (PR##), Line 1 (rear AV input), and Line 2 (front AV input).

- Input select is only available when the VCR deck is selected.

➤ *Before using the VCR operation of 11~25 pages, press the VCR button on the remote control to select VCR mode.*

*Before using the DVD operation of 26~42 pages, press the DVD button on the remote control to select and watch DVD.*

## Copying from DVD to VCR

The DVD-VCR allows you to copy the contents of a DVD to a VHS tape with a press of the COPY button.



*If the DVD you are attempting to copy is copy protected, you will not be able to copy the disc. It is not permitted to copy Macrovision® encoded DVDs.*

### 1 Insert Disc

Insert the disc you wish to copy in the DVD deck and close the drawer.

### 2 Insert VHS Tape

Insert a blank VHS videotape into the VCR deck.

### 3 Copy the DVD to VHS Tape

Press the COPY button on the DVD-VCR front panel.

- ◆ The DVD will go into Play mode and the VCR will go into Record mode.
- ◆ If the DVD disc menu appears, you may need to press the PLAY button manually to begin copying.

### 4 Stop the Copy Process

When the DVD is finished playing, press the VCR button on the remote control and then press the STOP button to end the copy.

- ◆ You must stop the Copy process manually when the DVD movie ends or the DVD may replay and record over and over again.

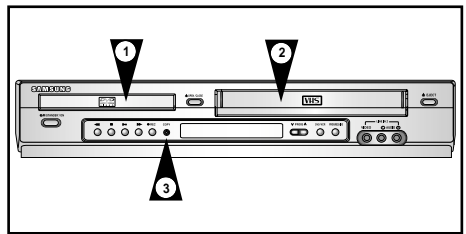

## Setting the Date and Time

Your DVD-VCR contains a 24-hour clock and calendar used to:

- ◆ Automatically stop programme recording
- ◆ Preset your DVD-VCR to record a programme automatically

You must set the date and time when:

- ◆ You purchase the DVD-VCR
- ◆ Do not forget to reset the time when you change clocks from winter to summer time and vice versa.

- 1 After pressing the MENU, press the OK or ►.  
Result: The Setup menu is displayed.



- 2 Press the corresponding ▲, ▼ buttons to select the **Clock** option.
- 3 Press the OK or ► to select this option.  
Result: The **Clock Set** menu is displayed.



- 4 Press ◀ or ► to select the hour, minutes, day, month and year.  
Result: The option selected highlight.
  - 5 Press the ◀ or ► buttons to increase or decrease the value.  
Result: The day of the week is displayed automatically.
- You can hold the ▲, ▼ buttons down to scroll more quickly through the values.
- 6 On completion, press RETURN to exit the menu.

## Setting the Menu Language

- 1 After pressing the MENU, press the OK or ►.  
Result: The Setup menu is displayed.

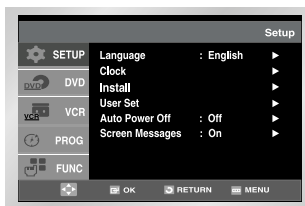

- 2 Use the ▲, ▼ buttons to highlight **Language**, then press the OK or ►.
- 3 Place the selection arrow next to your desired Language, then press the OK button.

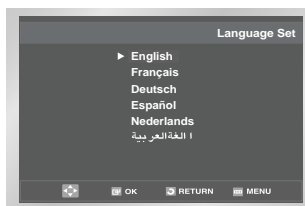

- 4 On completion, press RETURN to exit the menu.

## Presetting the Stations Automatically

☞ You do not need to preset the stations if you have already set them automatically (see Plug & Auto Set Up on page 9).

Your DVD-VCR contains a built-in tuner used to receive television broadcasts.

You must preset the stations received through the tuner. This can be done:

- ◆ Plug & Auto Set up (see page 9)
- ◆ Automatically
- ◆ Manually (see page 13)

You can store up to 80 stations.

- 1 After pressing the MENU, press the OK or ►. Result: The Setup menu is displayed.

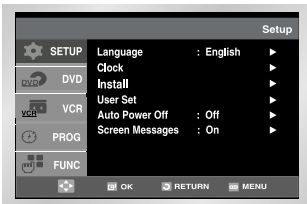

- 2 Press the corresponding ▲, ▼ buttons to select the **Install** option.
- 3 Press the OK or ► to select this option. Result: The **Install** menu is displayed.

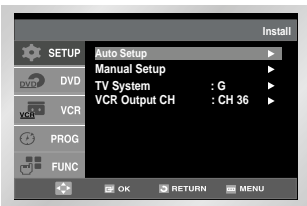

- 4 Press the corresponding ▲, ▼ buttons, until the **Auto Setup** is selected. And then press the OK or ► to select this option. Result: A message appears, indicating that any channels already preset on your DVD-VCR will be deleted.
- 5 Press OK to start the auto scanning.



Result: ◆ The **Please Wait** indication highlight on the television screen.

- ◆ The first frequency band is scanned and the first station found is displayed and stored.
  - ◆ The DVD-VCR then searches for the second station and so on.
  - ◆ When the automatic scanning procedure has finished, the DVD-VCR switches automatically to programme 1.
- The number of stations automatically stored by the DVD-VCR depends on the number of stations that it has found.

- 7 If you wish to cancel the auto scanning before the end, press the MENU button to exit the menu.

➤ *Once the auto scanning procedure has finished, some stations may have been stored more than once; select the stations with the best reception and delete the ones no longer required . (See page 14)*

# Presetting the Stations Manually

 You do not need to preset the stations manually if you have already set them automatically.

- 1 After pressing the MENU, press the OK or ► button.  
Result: The Setup menu is displayed.
- 2 Press the corresponding ▲, ▼ buttons to select the **Install** option.
- 3 Press the OK or ► button to select this option.  
Result: The **Install** menu is displayed.

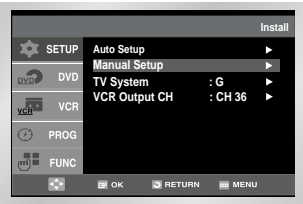

- 4 Press the corresponding ▲, ▼ buttons, until the **Manual Setup** option is selected.
- 5 Press the OK or ► button to select a **Manual Setup** option.  
Result: The **TV STATION TABLE** menu is displayed.

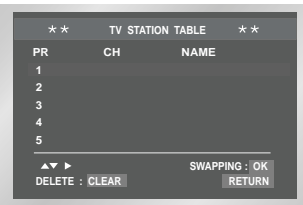

- 6 Press the ▲, ▼ buttons to select a programme number as required.
- 7 Press the ► button to preset the station.  
Result: The **MANUAL TUNING** menu is displayed.

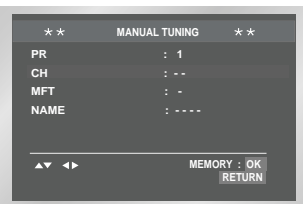

- 8 Press the ◀ or ▶ buttons to start scanning the channels.  
Result: The frequency band is scanned and the first station found is displayed.

- 9 Press the ▲, ▼ buttons until the **NAME** is selected. The station name is set automatically from the broadcast signal.

- 10 To change the programme's name, press the ► button.  
Result: The first letter of the name flashes.

## 11 To... Then...

Select a character in the name	Press the ▲, ▼ button until the required character is displayed (letters, numbers or “-” character).
--------------------------------	--

Move to the next or previous character	Press the ◀ or ▶ buttons respectively.
--	--

## 12 If you... Then...

Wish to store the station displayed	<ul style="list-style-type: none"> <li>◆ Press the ▲, ▼ buttons until the <b>MFT</b> is selected.</li> <li>◆ Press the ◀, ▶ buttons to adjust the picture, if necessary.</li> <li>◆ Press OK to store the station</li> </ul>
-------------------------------------	--

Do not wish to store the station displayed	<ul style="list-style-type: none"> <li>◆ Press the ▲, ▼ buttons until the <b>CH</b> is selected.</li> <li>◆ Press the ◀, ▶ buttons to go on scanning the frequency band and display the next station</li> <li>◆ Go back to the beginning of Step 14</li> </ul>
--	--

- 13 Repeat this procedure from Step 6 onwards, until all the required stations have been stored.

- 14 On completion, press the RETURN button three times to exit the menu.

## Clearing a Preset Station

☞ *If you have stored a TV station:*

- ◆ That you do not require
- ◆ At the wrong programme position you can cancel it.

- 1 After pressing the MENU, press the OK or ►.  
Result: The Setup menu is displayed.
- 2 Press the corresponding ▲, ▼ buttons to select the **Install** option.
- 3 Press the OK or ► to select this option.  
Result: The **Install** menu is displayed.

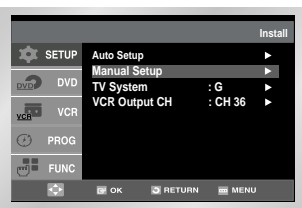

- 4 Press the corresponding ▲, ▼ buttons, until the **Manual Setup** option is selected.
- 5 Press the OK or ► to select a **Manual Setup** option.  
Result: The **TV STATION TABLE** menu is displayed.

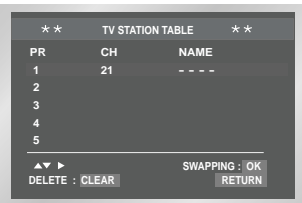

- 6 Press the corresponding ▲, ▼ buttons, until the required preset TV station (PR) is selected.
- 7 Press the CLEAR button.
- 8 Repeat the same procedure from Step 6 onwards until all the required stations have been cleared.
- 9 On completion, press the RETURN button four times to exit the menu.

## Changing the Preset Station Table

*You can rearrange the Station Table and give different programme numbers to the stations listed according to your own preferences.*

- 1 After pressing the MENU, press the OK or ►.  
Result: The Setup menu is displayed.
- 2 Press the corresponding ▲, ▼ buttons to select the **Install** option.
- 3 Press the OK or ► buttons to select this option.  
Result: The **Install** menu is displayed.

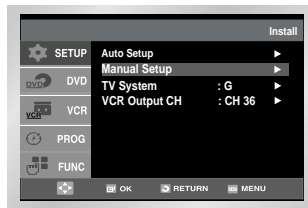

- 4 Press the corresponding ▲, ▼ buttons, until the **Manual Setup** option is selected.
- 5 Press the OK or ► button to select this option.  
Result: The **TV STATION TABLE** menu is displayed.

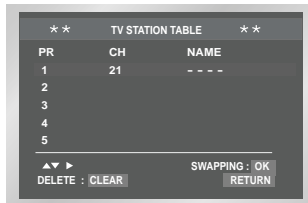

- 6 Press the corresponding ▲, ▼ buttons, until the required preset TV programme is selected.  
Result: The selected station is displayed at the same time on the television screen.
- 7 To change the programme number assigned to a station press the OK button on the remote control. (For example, To move a TV station in programme 1 to programme 3)

- 8 Press the ▲, ▼ buttons to select required position. And then press OK again to swap the position.
- 9 On completion, press the RETURN button four times to exit the menu.

## Selecting the RF OUT Sound Mode (B/G-D/K)

You can choose the sound mode (B/G or D/K) according to the TV set connected to your VCR.

- 1 After pressing the MENU, press the OK or ►. Result: The Setup menu is displayed.
- 2 Press the corresponding ▲, ▼ buttons to select the **Install** option.
- 3 Press the OK button to select this option. Result: The **Install** menu is displayed.
- 4 Press the OK or ► buttons, until the **TV System** option is selected.

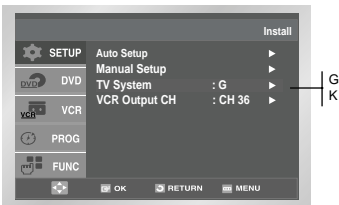

- 5 Press the OK or ► button to select G or K.
- 6 On completion, press RETURN to exit the menu.

## Setting the DVD-VCR Output Channel

Your DVD-VCR output channel may need to be changed if the pictures suffer from interference or if your TV cannot find the pictures. Also, you can change the DVD-VCR output channel to adjust the frequency in which information is displayed on the screen.

- 1 After pressing the MENU, press the OK or ►. Result: The Setup menu is displayed.
- 2 Press the corresponding ▲, ▼ buttons to select the **Install** option.
- 3 Press the OK or ► to select this option. Result: The **Install** menu is displayed.

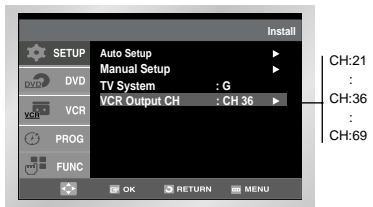

- 4 Press the ▲, ▼ buttons, until the **VCR Output CH** option is selected.
- 5 Select the required output channel (CH21~CH69) by pressing the OK or ► buttons. and ◀ buttons.

→ CH21 ↔ .. CH36 ↔ .. CH69 ←

- 6 On completion, press RETURN to exit the menu. Then tune your television again (see page 9).



## Selecting the Colour Mode

Before recording or playing back a cassette, you can select the required system standard.

- When you playback an NTSC-recorded tape on this DVD-VCR make a setting on the colour system according to your TV. If your TV is a PAL system only TV, set NTPB. If your TV is Multi System TV (NTSC 4.43 compatible), set NT4.43 and you can record NT4.43.

- 1 After pressing the MENU, press the OK or ►. Result: The Setup menu is displayed.
- 2 Press the corresponding ▲, ▼ buttons to select the **User Set** option.
- 3 Press the OK or ► to select this option. Result: The **User Set** menu is displayed.

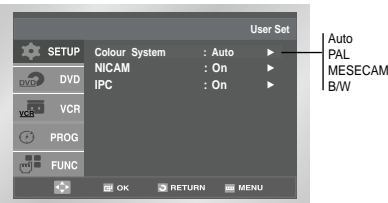

- 4 Press the corresponding ▲, ▼ buttons, until the **Colour System** option is selected.
  - 5 Press the OK or ► button to select **Auto** → **PAL** → **MESECAM** → **B/W**.
- |            |                 |
|------------|-----------------|
| <b>B/W</b> | Black and White |
|------------|-----------------|
- 6 On completion, press RETURN three time to exit the menu.

## NICAM ★ (DVD-V540/DVD-V440)

NICAM programmes are divided into 3 types. NICAM Stereo, NICAM Mono and Bilingual (transmission in another language). NICAM programmes are always accompanied by a standard mono sound broadcast and you can select the desired sound. Please refer to page 21.

- 1 After pressing the MENU, press the OK or ►. Result: The Setup menu is displayed.
- 2 Press the corresponding ▲, ▼ buttons to select the **User Set** option.
- 3 Press the OK or ► to select this option. Result: The **User Set** menu is displayed.

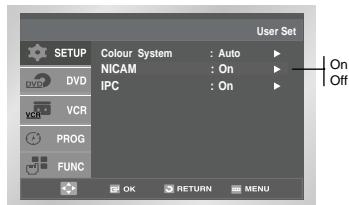

- 4 Press the corresponding ▲, ▼ buttons, until the **NICAM** option is selected.

- | 5 To...    | Press OK or ►, until...  |
|------------|--|
| Mono mode  | <b>Off</b> is displayed.<br>Off: Only set at this position to record the standard mono sound during a NICAM broadcast if the stereo sound is distorted due to inferior reception conditions. |
| NICAM mode | <b>On</b> is displayed.<br>On: Normally set at this position.  |
- 6 On completion, press RETURN three times to exit the menu.

## Intelligent Picture Control

*The Intelligent Picture Control Feature allows you to adjust the sharpness of the image automatically, according to your own preferences.*

- 1 During playback, press the MENU button on the remote control.
- 2 Press the OK or ► button.  
**Result:** The Setup menu is displayed.
- 3 Press the corresponding ▲, ▼ buttons to select the **User Set** option.
- 4 Press the OK or ► buttons to select this option.  
**Result:** The **User Set** menu is displayed.

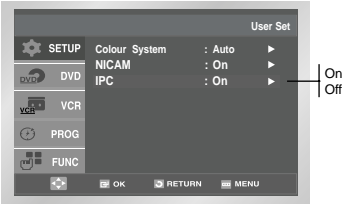

- 5 Press the corresponding ▲, ▼ buttons, until the **IPC** option is selected.
- 6 Press the OK or ► buttons to select the IPC (intelligent picture control) option.
  - When intelligent picture control mode is **ON**, the sharpness of the image is adjusted automatically.
- 7 To adjust the sharpness manually, press the ▼ button to turn the IPC mode **OFF**.
- 8 Press the ◀ or ▶ buttons until the picture is displayed according to your preferences.
  - If you do not press a button within ten seconds, the **PICTURE** menu disappears automatically.
- 9 On completion, press the RETURN button.

## Auto Power off

*The Auto Power Off feature automatically turns off your DVD-VCR if no signal is received and you do not press any button for the selected time.*

- 1 After pressing the MENU, press the OK or ► button.  
**Result:** The Setup menu is displayed.

- 2 Press the corresponding ▲, ▼ buttons, until the **Auto Power Off** option is selected.

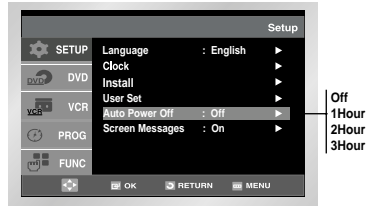

- 3 Press the OK or ► buttons, until you select the time of Auto Power Off interval.

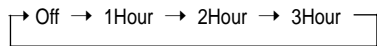

- 4 On completion, press return twice to exit the menu.

## Screen Messages

*Your DVD-VCR displays most information both on the DVD-VCR and the television.*

*You can choose to display or hide this information on the television screen (except for the SEARCH, Programming MENU and Timer functions, which cannot be hidden).*

- 1 After pressing the MENU, press the OK or ► button.
- 2 Press the corresponding ▲, ▼ buttons, until the **Screen Messages** option is selected.



- 3 To... Press OK or ►, until...

Display on-screen information **On** is displayed.

Hide on-screen information **Off** is displayed.

- 4 On completion, press RETURN twice to exit the menu.

## Selecting the Cassette Type

If you wish to use the tape counter to display the time remaining on a cassette, you must indicate the type of cassette inserted.

- 1 After pressing the MENU press the corresponding ▲, ▼ buttons to select the **VCR** option.
- 2 Press the OK or ► buttons to select this option.  
Result: The **VCR Setup** menu is displayed.
- 3 Press the corresponding ▲, ▼ buttons, until the **Tape Select** option is selected.



- 4 Press the OK or ► buttons as many times as required, until the correct cassette length is displayed.

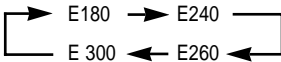

- 5 Press RETURN twice to exit the menu.

## Repeat Play

You can set repeat play to repeat the tape continuously from beginning to end.



To... Press OK or ►, until...

Repeat play **On** is displayed.

Do not wish to repeat play **Off** is displayed.

## Selecting the Recording Speed

You can record a cassette at two different speeds:

- ◆ **SP (Standard Play)**
- ◆ **LP (Long Play)**

**In Long Play modes:**

- ◆ Each cassette lasts twice as long
- ◆ The recording is of a slightly lower quality

To record a cassette... Press the SPEED button on the remote control, until...

In standard play mode **SP** is displayed.

In long play mode **LP** is displayed.

Type	Recording Time (in SP)
<b>E-180</b>	<b>180 mins. or 3 hours</b>
<b>E-240</b>	<b>240 mins. or 4 hours</b>
<b>E-260</b>	<b>260 mins. or 4 hours and 20 mins.</b>
<b>E-300</b>	<b>300 mins. or 5 hours</b>

## S-VHS Play

The DVD-VCR allows you to playback high quality S-VHS tapes.



To... Press OK or ►, until...

S-VHS play **On** is displayed.

Do not wish to S-VHS play **Off** is displayed.

## Recording a Programme Immediately

Before recording a programme, you must have preset the corresponding station (unless you are recording via an external video source). If you have not done so, refer to pages 11 and 12.

- 1 Switch on the television.
  - 2 To monitor the programme being recorded, select the television channel reserved for use with your DVD-VCR (or the AV input if used).
  - 3 Insert the cassette on which the programme is to be recorded, with the window visible and the safety tab intact or the opening covered with adhesive tape.  
Result: The DVD-VCR is switched on automatically.
  - 4 Select:
    - ◆ The station to be recorded using the PROG (Λ or ∨) buttons  
or
    - ◆ The LINE1, LINE2 source using the INPUT SEL. button for a satellite tuner or external video sourceResult: The station number is displayed and the programme can be seen on the television.
  - 5 Select the recording speed by pressing the SPEED button as many times as required (see page 18).
  - 6 Hold REC (●) down for a while to start recording.  
Result: The record indicator appears on the television and DVD-VCR display. An index is recorded on the tape (see page 22).
  - 7 To stop recording, press ■ once.
- ◆ If your DVD-VCR ejects the cassette when you start recording, check to make sure that the cassette's safety tab is intact or that the opening (created by a broken safety tab) is covered with adhesive tape.
- ◆ If you reach the end of the tape while recording, the cassette rewinds automatically.

## Protecting a Recorded Cassette

Video cassettes have a safety tab to prevent accidental erasure. When this tab has been removed, you cannot record on the tape.

- 1 If you wish to protect a cassette, break off the tab using a small screwdriver.
- 2 To re-record over a protected cassette (safety tab broken), cover the hole with adhesive tape.

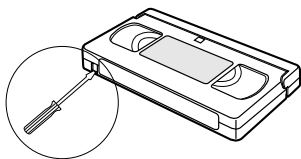

## Recording a Programme with Automatic Stop

This function enables you to record up to nine hours (LP) of programmes.

Your DVD-VCR stops automatically after the requested length of time.

- 1 Switch on the television.
  - 2 To monitor the programme being recorded, select the television channel reserved for use with your DVD-VCR (or the AV input if used).
  - 3 Insert the cassette on which the programme is to be recorded, with the window visible and the safety tab intact or the opening covered with adhesive tape.  
Result: The DVD-VCR is switched on automatically.
  - 4 Select:
    - ◆ The station to be recorded using the PROG (Λ or ∨) buttons  
or
    - ◆ The LINE1, LINE2 source using the INPUT SEL. button for a satellite tuner or external video sourceResult: The channel number is displayed and the programme can be seen on the television.
  - 5 Select the recording speed by pressing the SPEED button as many times as required. (see page 18)
  - 6 Hold the REC button (●) down for a while to start recording.  
Result: The record indicator appears on the television screen and DVD-VCR display. An index is recorded on the tape. (see page 22)
  - 7 Press the REC button (●) several times to increase the recording time in:
    - ◆ 30-minute intervals up to four hours
    - ◆ 1-hour intervals up to nine hoursResult: The length is displayed on the television displays. The selected programme is recorded for the length of time requested. At the end of that time, the DVD-VCR stops recording automatically and power off.
  - 8 If you wish to cancel the recording before the end, press STANDBY/ON.
- If the end of the tape is reached while recording:
  - ◆ The recording stops and power off.

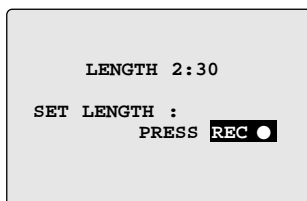

## Using the Timer Programming Feature

The **Timer Programming** feature allows you to preset the DVD-VCR to record a programme up to one month before that programme is to be broadcast. Up to six programmes can be preset.

☛ Before presetting a recording, check that the date and time are correct.

- 1 Insert the cassette and press **TIMER** on the remote control.  
Result: The **Timer Program** menu is displayed.
- 2 Press **▶** to select the input source.

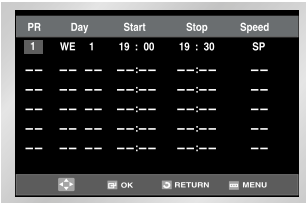

- 3 Select the required station by pressing the **▲**, **▼** buttons or **INPUT SEL.** to select the **LINE1**, **LINE2** input sources.
- 4 Press **▶** to select the recording day.
- 5 Select the required day by pressing the **▲**, **▼** buttons.
- 6 Press **▶** to select the recording start time.
- 7 Select the required hour value by pressing the **▲**, **▼** buttons.
- 8 Press **▶** to select the minutes.
- 9 Select the required minute value by pressing the **▲**, **▼** buttons.
- 10 Press **▶** to select the recording stop time.
- 11 Select the required recording stop time by pressing the **▲**, **▼** buttons, following the same procedure as when selecting the recording start time.
- 12 Press **▶** to select the recording speed.
- 13 Press the **▲**, **▼** buttons to select the **SP** (Standard Play), **LP** (Long Play), **Auto** (Auto Tape speed Select) recording speeds.

- 14 When you have finished, press the **RETURN** button.
- 15 Press the **STANDBY/ON** button to activate the timer.  
Result: Before starting recording, the DVD-VCR compares the timer duration with the remaining time on the cassette.

➤ *Auto Tape Speed select.* The DVD-VCR's "Auto Tape Speed select" function compares the duration of the timer recording to the actual recording time remaining on the tape loaded. If there is insufficient tape to complete a timer recording in **AUTO** mode, the DVD-VCR automatically switches to **LP** mode to record the whole programme.

## Checking a Preset Recording

You can check your preset recordings:

- ◆ When you have finished presetting the DVD-VCR
- ◆ If you have forgotten which programmes will be recorded

- 1 Press **TIMER** on the remote control.  
Result: The **TIMER PROGRAMMING** menu is displayed.
- 2 Press the **▲**, **▼** buttons to select the required programme.
- 3 Press the **◀** or **▶** buttons to select and change any values as required. For more details, refer to the previous page.
- 4 On completion, press **RETURN** twice.

## Canceling a Preset Recording

You can cancel any programmes that are:

- ◆ **Incorrect**
  - ◆ **No longer required**
- 1 Press **TIMER** on the remote control.  
Result: The **TIMER PROGRAMMING** menu is displayed.
  - 2 Select the programme to be cancelled by pressing the **▲**, **▼** buttons.
  - 3 Press the **CLEAR** button to cancel the selected programme.  
Result: All the recording information is deleted and the broadcast will not be recorded.
  - 4 On completion, press **RETURN** twice.

## Playing a Cassette

This function allows you to play back any pre-recorded cassette.

- 1 Switch on both the television and your DVD-VCR.
- 2 Insert the video cassette to be played. If the safety tab on the cassette is intact, press **▶II**.  
Otherwise, the cassette is played automatically.
  - When a cassette is loaded, the tape position is optimized automatically to reduce disturbance (Digital Auto Tracking).  
When playing a cassette, if the end of the tape is reached, the cassette is rewound automatically.

To...	Then press...
Stop the playback	■ (STOP).
Eject the cassette	▲ (EJECT).

## Adjusting Picture Alignment Manually

The **Picture Adjustment** feature allows you to adjust the alignment manually to obtain the best possible picture.

When noise bars or streaks appear during playback, adjust alignment manually by pressing the **TRK** buttons until the picture is clear and stable.

- Result:
- ◆ The tracking bar appears.
  - ◆ The image is adjusted.
  - ◆ The tracking bar disappears when you release the button.

## Selecting the Audio Output Mode

You can select the mode in which the sound is reproduced on the loudspeakers and AV outputs. The following options are available.

Option	Description
L	Used to listen to the sound on the left Hi-Fi channel.
R	Used to listen to the sound on the right Hi-Fi channel.
MIX	Used to listen to the mixed sound of the Hi-Fi and normal channels.
MONO	Used to listen to the sound on the normal mono channel.
L R	Used to listen to Hi-Fi stereo sound on the left and right channels. <ul style="list-style-type: none"><li>➤ When playing back tapes recorded in Hi-Fi, the sound switches to Hi-Fi after five seconds of Mono.</li></ul>

To select the sound mode, simply press the **AUDIO** button on the remote control until the required option is displayed.

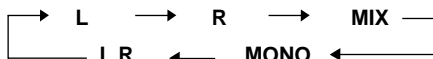

## Playing a Cassette in Slow Motion

You can play a cassette in slow motion.

- No sound is heard when playing back a cassette in slow motion.

- Press:
  - ◆ ►|| to start playing the cassette
  - ◆ ►|| button one more time to make still mode.
  - ◆ ►► to start SLOW mode.
  - ◆ ◀◀ or ►► button as many times as required to decrease or increase the speed respectively
  - ◆ To return to the normal speed, press the ►|| button twice.
- When playing back in slow motion, picture interference may occur. Press the TRK buttons to minimize this effect.
  - ☞ When you have been using the Slow Motion function for more than about two minutes, the DVD-VCR will automatically play to protect the:
    - ◆ Cassette
    - ◆ Video heads

## Playing a Sequence Frame by Frame

You can

- ◆ Stop the cassette at a given frame (image)
  - ◆ Advance one frame at a time
    - No sound is heard when playing back frame by frame.
- Press:
    - ◆ ►|| to start playing the cassette
    - ◆ ►|| button one more time to make still mode.
    - ◆ F.ADV/STEP to advance frame by frame
  - To return to normal playback, press ►||.
    - Vertical stability: When playing back frame by frame, interference may be seen on the screen. Press the TRK buttons to minimize this effect.

## Playing a Sequence at Variable Speeds

You can vary the playback speed using the Shuttle function (up to nine times the normal speed).

**Example:** You wish to analyse a sportsperson's technique, movement by movement.

The Shuttle function is available on the Remote control

- No sound is heard when playing a sequence at variable speeds.

- Press:
  - ◆ ►|| during playback
  - ◆ SHUTTLE (<<) to play the cassette backwards
  - ◆ SHUTTLE (>>) to play the cassette forwards
- Each time you press a SHUTTLE button, the speed is changed as shown in the following illustration.

REVERSE PLAY X9	REVERSE PLAY X5	REVERSE PLAY X3	STILL	SLOW MOTION X1/10	SLOW MOTION X1/5	PLAY	PLAY X3	PLAY X5	PLAY X9
-----------------------	-----------------------	-----------------------	-------	-------------------------	------------------------	------	------------	------------	------------

## Searching for a Specific Sequence

Each time you record a cassette on this DVD-VCR, an "index" is automatically marked on the tape when recording starts.

The Search function allows you to fast-forward or rewind to a specific index and start playback from that point. Depending on the direction selected, the indexes are numbered as follows:

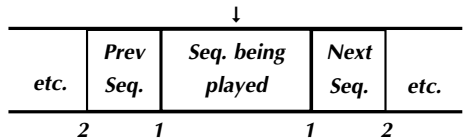

- This DVD-VCR uses a standard indexing system (VISS). As a result, it will recognize any indexes marked by other VCRs using the same system and vice versa.

## Searching for a Specific Sequence

### Go To [0:00:00] Stop

Use this feature when you want to search for the 0:00:00 counter position on a cassette. Press the CLEAR button on the tape where you want to set the counter to 0:00:00.

The VCR will rewind or fast forward, searching for the 0:00:00 counter position, and then automatically stop at that position.

- 1 After pressing the SEARCH, press the corresponding ▲, ▼ buttons, until the Go To [0:00:00] option is selected.

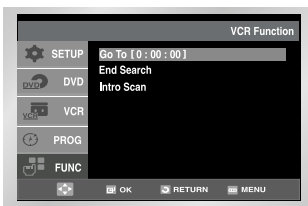

- 2 Press the OK or ►.

### End Search

Use this feature when you want to search for a blank position to record a program on a cassette.

The VCR will fast forward, searching for a blank position, and then automatically stop at that position. If the VCR reaches the end of the tape during end search, the tape will be ejected.

### Intro Scan

- 1 After pressing the SEARCH, press the corresponding ▲, ▼ buttons, until the **Intro Scan** option is selected.
- 2 Press the OK or ►.
- 3 Press the ◀ or ▶ buttons depending on the direction where your desired programme is located.
- 4 When an Index mark is found the DVD-VCR will playback the tape for 5 seconds, after which it will continue searching for the next Index mark.
- 5 If you want to watch the tape from a particular Index, simply press ►|| twice.



### Index Skip Search

This feature will enable you to fast forward/rewind to a specific point on a tape: E.g. if you have recorded 3 different programmes on a tape and you have rewound the tape to the beginning, by using this feature you can go directly to the start of programme 2 simply by pressing the SEARCH button.

- 1 After pressing the SEARCH, press the corresponding ▲, ▼ buttons, until the **Intro Scan** option is selected.
- 2 Press the OK or ►.
- 3 Press the ◀ or ▶ buttons twice more. This will take you directly to the start of the desired programme is located.
- 4 These Index searches can be made forwards: (press ▶) or backwards: (press ◀). (◀◀ -20 . . 0 . . +20 ▶▶)
- 5 To cancel an Index search simply press the ►|| or ■ button.



## Using the Tape Counter

*The tape counter:*

- ◆ Indicates the elapsed time in the play and record modes (hours, minutes and seconds)
- ◆ Is reset when a cassette is inserted in the DVD-VCR
- ◆ Allows you to find the beginning of a sequence easily

☞ *If the remaining time is to be calculated correctly, you must indicate the type of cassette being used.*

- 1 Insert a cassette in your DVD-VCR.
- 2 To set the tape counter to zero at the beginning of a sequence:
  - ◆ Press INFO. twice to display the counter
  - ◆ Press CLEAR when you want to set the tape counter to zero.



## Using the Tape Counter

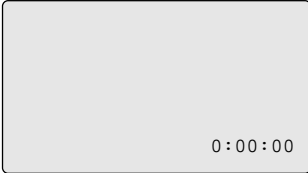

- 3 When you are ready,
  - ◆ Start playback or Recording.
  - ◆ Press the **■** button.
  - ◆ To fast-forward or rewind to the sequence at which the counter was set to zero, press **◀◀** or **▶▶**.

➤ Some DVD-VCR information, such as the counter, can be displayed on the television screen (unless you have deactivated the Screen messages mode; refer to page 17).

Press INFO.:

- ◆ Once to display the current function, programme number, recording speed, date, time and counter
- ◆ Twice to display the counter only
- ◆ Three times to display the time remaining on the cassette
- ◆ Four times to clear the display

## Using the Assemble Edit Function

*This function allows you to start a new recording at a specific position on the cassette while maintaining a very smooth scene change.*

- 1 Insert the cassette to be edited in your DVD-VCR.
- 2 Press the **▶||** button to start playback.
- 3 When you reach the position from which you wish to start the new recording, press the **▶||** button.
- 4 Press the F.ADV/STEP button again as often as necessary to advance frame by frame, until the exact recording position is located.
- 5 While the DVD-VCR is in still mode, hold the REC button (●) down for a while to activate the Assemble Edit function.
- 6 Select the source from which you wish to record by pressing:
  - ◆ The PROG buttons for television channels
  - ◆ The INPUT SEL. button for the LINE input sources
- 7 Press the **▶||** button to start recording.
- 8 When you have finished recording, press **■**.

## Connecting an RCA Audio/Video Input Cable

*You can connect other audio/video equipment to your DVD-VCR using audio/video cables if the appropriate outputs are available on the equipment chosen.*

**Examples:** ◆ *You wish to copy a video cassette with the help of a second VCR.*

- ◆ *You wish to play back and/or copy pictures taken with a camcorder.*

⚡ *Make sure that both the television and the DVD-VCR are switched off before connecting the cables.*

- 1 Connect one end of the RCA audio/video cable into the VIDEO INPUT socket on the front of the DVD-VCR.
- 2 Plug the other end of the audio/video cable into the appropriate output connector on the other system (VCR or camcorder).
- 3 Connect one end of the RCA audio cable supplied into the AUDIO INPUT sockets on the front of the DVD-VCR.
  - Take care to respect the colour coding of the left and right channels.
- 4 Plug the other end of the audio cable into the appropriate output connectors on the other system (VCR, camcorder or Hi-Fi sound system).

(DVD-V540/DVD-V440)

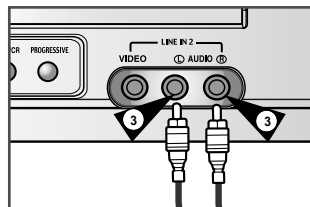
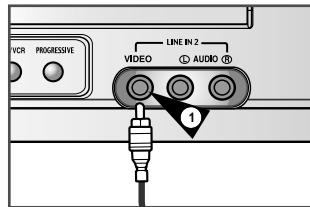

(DVD-V340)

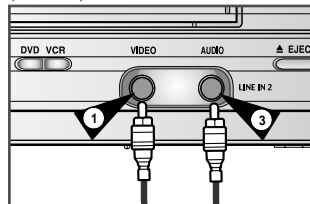

## Recording from Another VCR or Camcorder

You can copy a cassette to your DVD-VCR from another video source, such as another VCR or a camcorder.

- ☞ It is an infringement of copyright laws to copy prerecorded cassettes or to re-record them in any form without the permission of the owners of the corresponding copyright.
  - 1 Connect the DVD-VCR, from which the cassette is to be copied, to the appropriate RCA audio and video input connectors on the rear of your DVD-VCR, as indicated on page 8.
  - 2 Insert a blank cassette in your DVD-VCR.
  - 3 Insert the pre-recorded cassette in the other video source (VCR or camcorder).
  - 4 Press the INPUT SEL. button to select the appropriate input on your DVD-VCR: LINE IN for the RCA input.
  - 5 Start playing back the cassette to be copied.
  - 6 Hold REC (●) down for a while to start recording on your DVD-VCR.
  - 7 When you have finished recording, press ■ on both VCR and DVD-VCR.
- If you wish to view the cassette being copied:
- ◆ Your DVD-VCR must be connected as usual to the television (see page 7-8 for further details)

## Using the TV Buttons on the Remote Control ★ (DVD-V540 Only)

Your DVD-VCR remote control will work with Samsung televisions and compatible brands.

To determine whether your television is compatible, follow the instructions below.

- 1 Switch your television on.
- 2 Point the remote control towards the television.
- 3 Hold down the TV button and enter the two-figure code corresponding to the brand of your television, by pressing the appropriate numeric buttons.

Brand	Codes	Brand	Codes
SAMSUNG	01 to 06	PHILIPS	02, 20, 22
AKAI	09, 23	SABA	13, 14, 22 to 24
GRUNDIG	09, 17, 21	SONY	15, 16
LOEWE	02	THOMSON	13, 14, 24
PANASONIC	08, 23 to 27	TOSHIBA	07, 16 to 19, 21

**Result:** If your television is compatible with the remote control, it will switch off. It is now programmed to operate with the remote control.

- If several codes are indicated for your television brand, try each one in turn until you find one that works.

☞ When you change the batteries in the remote control, you must reprogramme the code, following the same procedure.

You can then control the television using the following buttons.

Button	Function
STANDBY/ON	Used to switch the television and DVD-VCR on and off.
TV or VCR	Used to switch between the TV and VCR modes.
INPUT SEL.	Used to select an external source.
VOL + or -	Used to adjust the volume of the television.
PROG/TRK ( ^ or √ )	Used to select the required programme.
TV MUTE	Used to mute the volume of the television.

- The various functions will not necessarily work on all televisions. If you encounter problems, operate the television directly.

## Choosing a Connection

The following show examples of connections commonly used to connect the DVD -VCR player with a TV and other components. It is only available for DVD. The VCR out can not watch by this connection.

### Connection to an Audio System

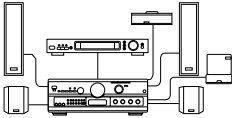

### Connection to a Television



### Dolby Digital Decoder Digital Audio Input Jack

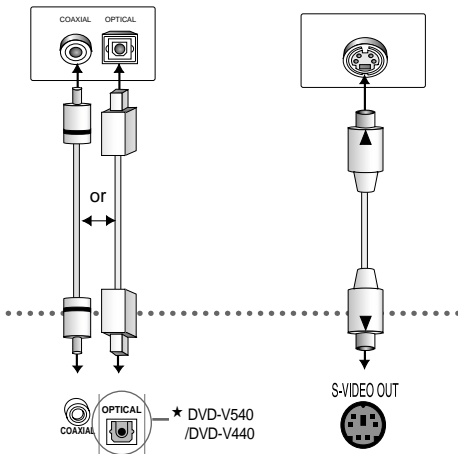

### Digital Audio out Jack

### S-Video Jack

## Setting Up the Language Features

If you set the player menu, disc menu, audio and subtitle language in advance, they will come up automatically every time you watch a movie.

### Using the Disc Menu Language

This function changes the text language only on the disc menu screens.

- 1 With the unit in Stop mode, press the MENU button.
- 2 Select DVD using ▲, ▼ buttons, then OK or ► button



- 3 Select **Language Setup** using ▲, ▼ buttons, then press the OK or ► button.



- 4 Select **Disc Menu** using ▲, ▼ buttons, then press the OK or ► button.
- 5 Use the ▲, ▼ buttons to select 'English'.  
- Select "Others" if the language you want is not listed.



- 6 Press the OK button.  
- English is selected and the screen returns to Language Setup menu.

# Setting Up the Language Features

## Using the Audio Language

- 1 With the unit in Stop mode, press the MENU button.
- 2 Select DVD using ▲,▼ buttons, then OK or ► button.
- 3 Select **Language Setup** using ▲,▼ buttons, then press the OK or ► button.

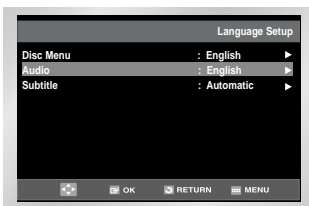

- 4 Select **Audio** using ▲,▼ buttons, then press the OK or ► button.
- 5 Press the ▲,▼ buttons to select **English**.
  - Select "Original" if you want the default soundtrack language to be the original language the disc is recorded in.
  - Select "Others" if the language you want is not listed.

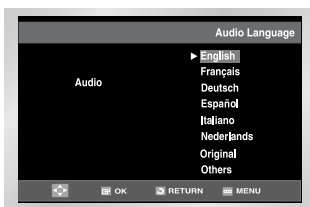

- 6 Press the OK button.
  - English is selected and the screen returns to **Language Setup** menu.

## Using the Subtitle Language

- 1 With the unit in Stop mode, press the MENU button.
- 2 Select DVD using ▲,▼ buttons, then OK or ► button.
- 3 Select **Language Setup** using ▲,▼ buttons, then press the OK or ► button.



- 4 Select **Subtitle** using ▲,▼ buttons, then press the OK or ► button.
- 5 Use the ▲,▼ buttons to select **English**.
  - Select "Automatic" if you want the subtitle language to be the same as the language selected as the audio preference.



- Select "Others" if the language you want is not listed. Some discs may not contain the language you select as your initial language; in that case the disc will use its original language setting.
- 6 Press the OK button.
  - English is selected and the screen returns to **Language Setup** menu.

# Setting Up the Audio Options

- 1 With the unit in Stop mode, press the MENU button.
- 2 Select DVD using ▲, ▼ buttons, then OK or ► button.

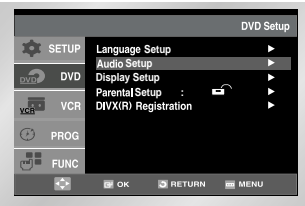

- 3 Select **Audio Setup** using ▲, ▼ buttons, then press the OK or ► button.
- 4 Use the ▲, ▼ buttons to select the desired item. Then press the OK or ► button.

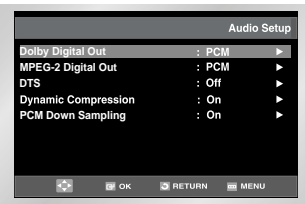

## ■ Dolby Digital Out

1. PCM : Converts to PCM(2CH) audio. Select PCM when using the Analog Audio Outputs.
2. Bitstream : Converts to Dolby Digital Bitstream (5.1CH). Select Bitstream when using the Digital Audio Output.

➤ Be sure to select the correct Digital Output or no audio will be heard.

## ■ MPEG-2 Digital Out

1. PCM : Converts to PCM(2CH) audio. Select PCM when using the Analog Audio Outputs.
2. Bitstream : Converts to MPEG-2 Digital Bitstream (5.1CH or 7.1CH). Select Bitstream when using the Digital Audio Output.

## ■ DTS

1. Off : Doesn't output digital signal.
2. On : Outputs DTS Bitstream via digital output only. Select DTS when connecting to a DTS Decoder.

## ■ Dynamic Compression

1. On : To select dynamic compression.
2. Off : To select the standard range.

## ■ PCM Down Sampling

1. On : Select this when the amplifier connected to the player is not 96KHz compatible. In this case, the 96KHz signals will be down converted to 48KHz.
2. Off : Select this when the amplifier connected to the player is 96KHz compatible. In this case, all signals will be output without any changes.

➤ • How to make the SETUP menu disappear or return to menu screen during set up; Press RETURN or ◀ button.

• Manufactured under license from Dolby Laboratories. "Dolby" and the double-D symbol are trademarks of Dolby Laboratories.

• "DTS" and "DTS Digital Out" are trademarks of Digital Theater Systems, Inc.

# Setting Up the Display Options

- 1 With the unit in Stop mode, press the MENU button.
- 2 Select DVD using ▲, ▼ buttons, then OK or ► button.



- 3 Select **Display Setup** using ▲, ▼ buttons, then press the OK or ► button.
- 4 Use the ▲, ▼ buttons to select the desired item. Then press the OK or ► button.

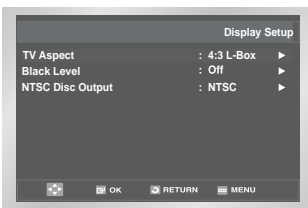

## ■ TV Aspect

Depending on the type of television you have, you may want to adjust the screen setting (aspect ratio).

1. 4:3 Letter Box : Select when you want to see the total 16:9 ratio screen DVD supplies, even though you have a TV with a 4:3 ratio screen. Black bars will appear at the top and bottom of the screen.
2. 4:3 Pan Scan : Select this for conventional size TVs when you want to see the central portion of the 16:9 screen. (Extreme left and right side of movie picture will be cut off.)
3. 16:9 Wide : You can view the full 16:9 picture on your widescreen TV.

## ■ Black Level

Adjusts the brightness of the screen.(On/Off)

## ■ NTSC Disc Output

"NTSC" if the screen only has one NTSC-video entrance. If this is not the case, you can choose to leave "PAL60" as is.

# Setting Up the Parental Control

The Parental Control function works in conjunction with DVDs that have been assigned a rating - which helps you control the types of DVDs that your family watches.

There are up to 8 rating levels on a disc.

- 1 With the unit in Stop mode, press the MENU button.
- 2 Select DVD using ▲, ▼ buttons, then OK or ► button.
- 3 Select **Parental Setup** using ▲, ▼ buttons, then press the OK or ► button.



- 4 Use OK or ► to select **Yes** if you want to use a password. The **Enter Password** screen appears.

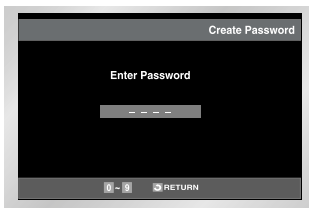
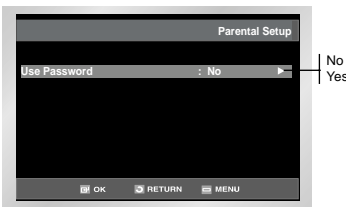

- 5 Enter your password. The **Re-Enter Password** screen appears to confirm the password. Enter your password again. The Parental Control screen appears.

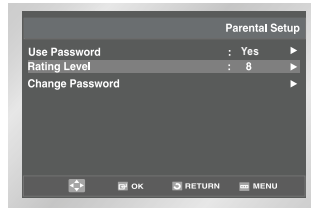

## ■ About the Rating Level ;

The Rating Level will work only when **Use Password** is set to Yes. To unlock the player, use ► or OK to select No. Use ▲, ▼ to select **Rating Level**. Press OK.

- Use ▲, ▼ to select the level (e.g. Level 6) and press OK. Discs that contain Level 7 will now not play.

- To cancel the rating level, use ► or OK to select No in Use Password.

## ■ About the Change Password ;

- Use ▲, ▼ to select Change Password. Press OK. The Change Password screen appears.

- Enter password. Re-Enter the new password again.

➤ How to make the SETUP menu disappear or return to menu screen during set up; Press RETURN or ◀ button.

• If you have forgotten your password, see Forget Password in the Troubleshooting Guide.

## A/V Receiver Connections

To take full advantage of the movie theater experience that DVD offers, you may want to connect your DVD-VCR to a complete Surround Sound system, including an A/V Receiver and six Surround Sound speakers.

**Before You Begin...**

- If your A/V receiver is equipped with a Dolby Digital Decoder, you have the option to bypass the DVD-VCR's built-in Dolby Digital Decoder. Use the Digital Audio Out connection below.

(DVD-V540/DVD-V440)

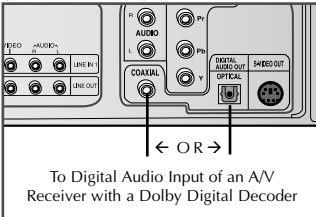

(DVD-V340)

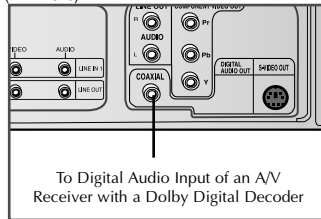

### 1 Digital Audio Out

Connect EITHER an optical cable OR a digital coaxial cable from the Digital Audio Out jacks on the back panel of the DVD-VCR to their corresponding Digital Audio Input jacks on your A/V Receiver:

- Optical ★ (DVD-V540/DVD-V440)
- Coaxial
- Use whichever connection is available on your A/V Receiver.

## Special Playback Features

During DVD/CD playback you can select from the following special playback options. To resume normal playback, press the ►II button.

### 1 Still

- Press the ►II button on the remote control during playback.
- The picture will still and the audio will mute.
- To resume playback, press the ►II button.
- If the player is left in Still mode for 5 minutes, it will stop automatically.

### 2 Frame Advance (Step)

While in playback mode, press the F.ADV/STEP button on the remote control to advance one frame at a time.

- Audio is muted during Frame Advance mode.
- Press ►II to resume normal playback.

NOTE: Frame Advance operates only in the forward direction.

### 3 Skip Forward/Back

While a CD or DVD disc is in Play mode, press the Skip I◀◀ / ▶▶I buttons on the remote control or front panel to jump forward and backward through disc chapters/tracks.

- Skip Forward will jump to the next chapter/track.
- Skip Back will jump to the beginning of the current chapter/track.
- Press Skip Back again to jump to the beginning of the previous chapter/track.

### Search Forward/Back

While a disc is in Play mode, press and hold the ◀◀ / ▶▶ buttons on the remote control or front panel to visually search forward/backward at 2X - 4X - 8X - 16X - 32X - 128X speed. Press ►II button to resume normal speed.

### 4 Slow Motion

During playback, press the ►II button to Still the image. Then use the Search ►► to play in slow motion at variable speeds.

- Each press increases the slow motion speed playback to 1/8, 1/4 or 1/2 normal speed.
- Audio is muted during slow motion playback.

### 5 Stop/Resume

- Press the Stop button once to stop playback. To resume the DVD/CD from the point where the disc stopped, press the ►II button.
- Press the ■ button twice to completely stop playback. The next time you press ►II, the disc will start over from the beginning.



## Component Connections (for DVD) ★ (DVD-V540/DVD-V440)

*Component video output is available only for DVD playback. RF and Line input are available for Tuner and VCR playback.*

*If your TV set supports Progressive Scan, it can transmit Pr, Pb, and Y signals separately, so you can enjoy sharp and clear picture.*

☞ *What is Progressive Scan?*

*It is a set of jacks that can provide sharp and clear picture quality by using twice the number of fields of lines than component output.*

- 1 Connect the component output of the DVD player to your TV set.

Use the component cable to connect the component output on the back panel of the DVD-VCR to the component input of your TV.

- ◆ If you mix up the connections when connecting the component cable, the picture will appear reddish or bluish.

- 2 Set your TV to COMPONENT.

Select component input as your TV's AV input. At this point, even if the picture appears reddish, it is normal.

- 3 Press the Progressive button on the front panel. If the Progressive button on the front panel of the DVD-VCR is pressed, the following message will be displayed:

To activate Progressive Scan, press OK.

The following message will be displayed and then the picture will be played in Progressive Scan mode.

- 4 To deactivate Progressive Scan, press the Progressive button again.

If the Progressive button on the front panel of the DVD-VCR is pressed again, Progressive Scan mode will be canceled. Select another mode as your TV's AV input to view another output of the DVD-VCR.

➤ This is available only for a TV set that supports Progressive Scan.

- ◆ While Progressive Scan is active, video, S-video, and RCA output are not available.
- ◆ To activate Progressive Scan, the DVD-VCR must be in Stop mode.

➤ You can listen to audio sound through Rear audio output while watching Component or S-Video output.

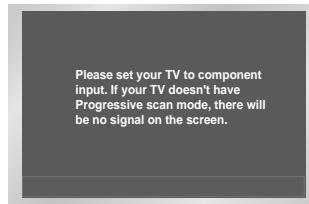

## Adjusting the Aspect Ratio (EZ View)

### *To play back using aspect ratio (DVD)*

- 1 Press the EZ VIEW button.
  - The screen size changes when the button is pressed repeatedly.
  - The screen zoom mode operates differently depending on the screen setting in the initial DVD menu.
  - To ensure correct operation of the EZ VIEW button, you should set the correct aspect ratio in the initial setup.

### *If you are using a 16:9 TV*

#### ■ For 16:9 aspect ratio discs

- **Wide Screen**  
Displays the content of the DVD title in 16:9 aspect ratio.
- **Screen Fit**  
The top and bottom of the screen are cut off. When playing a 2.35:1 aspect ratio disc, the black bars at the top and bottom of the screen will disappear. The picture will look vertically stretched. (Depending on the type of disc, the black bars may not disappear completely.)
- **Zoom Fit**  
The top, bottom, left and right of the screen are cut off and the central portion of the screen is enlarged.

#### ■ For 4:3 aspect ratio discs

- **Normal Wide**  
Displays the content of the DVD title in 16:9 aspect ratio. The picture will look horizontally stretched.
- **Screen Fit**  
The top and bottom of the screen are cut off and the full screen appears. The picture will look vertically stretched.
- **Zoom Fit**  
The top, bottom, left and right of the screen are cut off and the central portion of the screen is enlarged.
- **Vertical Fit**  
When a 4:3 DVD is viewed on a 16:9 TV, black bars will appear at the left and right of the screen in order to prevent the picture from looking horizontally stretched.

### *If you are using a 4:3 TV*

#### ■ For 16:9 aspect ratio discs

- **4:3 Letter Box**  
Displays the content of the DVD title in 16:9 aspect ratio. The black bars will appear at the top and bottom of the screen.
- **4:3 Pan Scan**  
The left and right of the screen are cut off and displays the central portion of the 16:9 screen.
- **Screen Fit**  
The top and bottom of the screen are cut off and the full screen appears. The picture will look vertically stretched.
- **Zoom Fit**  
When a 4:3 DVD is viewed on a 16:9 TV, black bars will appear at the left and right of the screen in order to prevent the picture from looking horizontally stretched.

#### ■ For 4:3 aspect ratio discs

- **Normal Screen**  
Displays the content of the DVD title in 4:3 aspect ratio.
- **Screen Fit**  
The top and bottom of the screen are cut off and the full screen appears. The picture would look vertically stretched.
- **Zoom Fit**  
The top, bottom, left and right of the screen are cut off and the central portion of the screen is enlarged.

➤ This function may behave differently depending on the type of disc.

# Using the Display Function

## When Playing a DVD/VCD/CD

- 1 During play, press the INFO. button on the remote.
- 2 Use the ▲, ▼ buttons to select the desired item.
- 3 Use the ◀, ▶ buttons to make the desired setup.
  - You may use the number buttons of the remote control to directly access a title, chapter or to start the playback from the desired time.

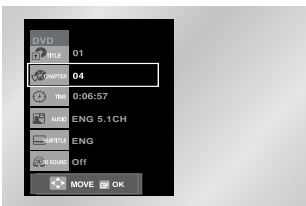
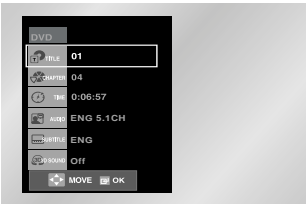
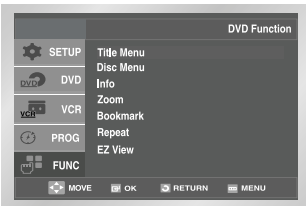



- 4 To make the screen disappear, press the INFO. button again.

- • **What is a Chapter?**  
*Each Title on a DVD is usually divided into chapters (similar to tracks on an audio CD).*
- **What is a Title?**  
*A DVD may contain several different titles. For example, if a disc contains four different movies, each might be considered a title.*

 To access the desired title when there is more than one in the disc. For example, if there is more than one movie on a DVD, each movie will be identified.

 Most of DVD discs are recorded in chapters so that you can quickly find a specific passage.

 Allows playback of the film from a desired time. You must ok the starting time as a reference.

 Refers to the language of the film soundtrack. In the example, the soundtrack is played in English 5.1CH. A DVD disc can have up to eight different soundtracks.

 Refers to the subtitle languages available in the disc. You will be able to choose the subtitles language or, if you prefer, turn them off from the screen. A DVD disc can have up to 32 different subtitles.

 A surround sound effect is generated using only two front speakers.

\* When in VCD 2.0 mode (MENU ON mode), this function does not work.

## Changing the Camera Angle

### Using the ANGLE button

When a DVD contains multiple angles of a particular scene, you can select the Angle function.

Press the ANGLE button to see if an ANGLE

(  ) mark is present at the upper Right hand corner of the screen.

- 1 When an ANGLE mark is shown, press the ANGLE button, then an ANGLE select icon will appear at the upper left hand corner of the screen.
- 2 Use the ◀, ▶ buttons to select the desired screen angle.
- 3 To turn off the display, press the ANGLE button again.



## Selecting the Subtitle Language

You can select a desired subtitle quickly and easily with the subtitle button.

### Using the SUBTITLE button

- 1 Press the SUBTITLE button.
- 2 Use the ◀, ▶ buttons to select the desired subtitle language.
- 3 Use the ▲, ▼ buttons to determine whether or not the subtitle will be displayed.
  - The subtitle languages are represented by abbreviations.



- This function depends on what languages are encoded on the disc and may not work with all DVDs.
- A DVD disc can contain up to 32 subtitle languages.
- How to have the same subtitle language come up whenever you play a DVD; Refer to "Setting Up the Language Features" on page 27.

## Repeat Play

Repeat the current track, chapter, title, a chosen section (A-B), or all of the disc.

### When playing a DVD

- 1 Press the REPEAT button on the remote. Repeat screen appears.
- 2 Select Chapter, Title or A-B using the ◀, ▶ buttons.
  - Press the REPEAT button. Select A-B on screen with the ◀, ▶ buttons.
  - Press OK at the point where you want the repeat play to start (A). The B is automatically highlighted.
  - Press OK at the point where you want the repeat play to stop (B).
  - To terminate the function, press the CLEAR button.
  - A-B REPEAT does not allow you to set point (B) until at least 5 seconds has elapsed after point (A) has been set.

DVD

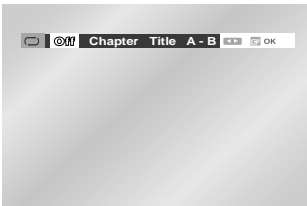

VCD / CD

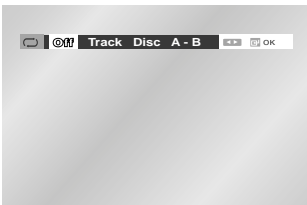

- 3 Press OK.
- 4 To return to normal play, press REPEAT again, then press the ◀, ▶ buttons to select Off and press OK.
  - It is available to press CLEAR button on the remote controller in order to stop REPEAT play.

- DVD repeats play by chapter or title, CD and VCD repeat play by disc or track.
  - Depending on the disc, the Repeat function may not work.
  - When in VCD 2.0 mode (MENU ON mode), this function does not work.

## Selecting the Audio Language

You can select a desired language quickly and easily with the AUDIO button.

### Using the Audio button

- 1 Press the AUDIO button.
- 2 Use the ◀, ▶ buttons to select the desired language on a DVD.
  - The audio languages are represented by abbreviations.
- 3 Use the ◀, ▶ buttons to select Stereo, ◀ or ▶ (On VCD/CD)

DVD



VCD / CD



- This function depends on what languages are encoded on the disc and may not work with all DVDs.
  - A DVD disc can contain up to 8 audio languages.
  - How to have the same audio language come up whenever you play a DVD ; Refer to "Setting Up the Language Features" on page 27.

## Using the Mark Function

This feature lets you mark sections of a DVD or VCD (MENU OFF mode) so you can quickly find them at a later time.

### Using the Mark Function (DVD/VCD)

- 1 During play, press the MARK button on the remote. The Mark icons will be displayed.

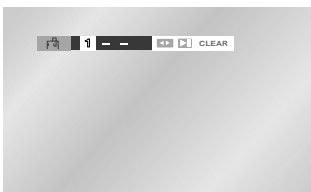
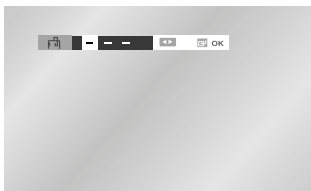

- 2 Use the ◀, ▶ buttons to move to the desired Mark icon.
- 3 When you reach the scene you want to mark, press the OK button. The icon will change to a number (1, 2, or 3).
- 4 Press the MARK button to turn off the display.

### Recalling a Marked Scene

- 1 During play, press the MARK button on the remote.
- 2 Use the ◀, ▶ buttons to select a marked scene.
- 3 Press the ►► buttons to skip to the marked scene.

### Clearing a Mark

- 1 During play, press the MARK button on the remote.
  - 2 Use the ◀, ▶ buttons to select the mark number you want to delete.
  - 3 Press the CLEAR button to delete a mark number. Press the MARK button to turn off the display.
- Up to three scenes may be marked at a time.
- When in VCD 2.0 mode (MENU ON mode), this function does not work.
  - Depending on the disc, the mark function may not work.

## MP3/WMA Play

If you insert an MP3/WMA Disc into the DVD player, you can see the folder directory.

- Select the desired folder in the root directory.
- Use the OK or ►► button to select the desired folder.

### MP3/WMA Play Function

- 1 Press the OK or ►► button, the selected music file will be played back. Up to 8 music folders can be displayed at a time. If you have more than 8 folders on a disc, press the ▼ button to display them on the screen.

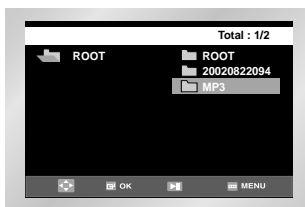

- 2 Use the ▲, ▼ buttons to select the desired music folder, then press OK. Press the ▲, ▼ buttons again to select a music file. Press the OK button to begin playback of a music file.

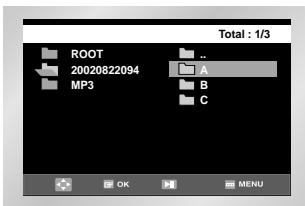

## MP3/WMA Play

### Program/Random playback

- 1 Press the MODE button in STOP mode to switch between the RANDOM and PROGRAM modes.



- • Press the REPEAT button in PLAY mode to hear only music continuously and press it once again to release.

### CD-R MP3/WMA discs

When playing CD-R/MP3 or WMA discs, please follow all the recommendations for CD-R above, plus the comments below:

- **Your MP3 or WMA files should be ISO 9660 or JOLIET format.**

ISO 9660 format and Joliet MP3 or WMA files are compatible with Microsoft's DOS and Windows, and with Apple's Mac. These two formats are the most widely used.

- **When naming your MP3 or WMA files do not exceed 8 characters, and place ".mp3, .wma" as the file extension.**

General name format of: Title.mp3. or Title.wma.  
When composing your title, make sure that you use 8 characters or less, have no spaces in the name, and avoid the use of special characters including: (.,/, \, =, +).

- **Use a decompression transfer rate of at least 128Kbps when recording MP3 files.**

Sound quality with MP3 files basically depends on the rate of compression/decompression you choose. Getting audio CD quality sound requires an analog/digital sampling rate, that is conversion to MP3 format, of at least 128 Kbps and up to 160 Kbps. However, choosing higher rates, like 192 Kbps or more, only rarely give better sound quality. Conversely, files with decompression rates below 128 Kbps will not be played properly.

- **Use a decompression transfer rate of at least 64Kbps when recording WMA files.**

Sound quality with WMA files basically depends on the rate of compression/decompression you choose. Getting audio CD quality sound requires an analog/digital sampling rate, that is conversion to WMA format, of at least 64Kbps and up to 192Kbps. Conversely, files with decompression rates below 64Kbps or over 192Kbps will not be played properly.

- **Do not try recording copyright protected MP3 files.**

Certain "secured" files are encrypted and code protected to prevent illegal copying. These files are of the following types: Windows Media™ (registered trade mark of Microsoft Inc) and SDMITM (registered trade mark of The SDMI Foundation). You cannot copy such files.

- **Important :**

The above recommendations cannot be taken as a guarantee that the DVD player will play MP3 recordings, or as an assurance of sound quality. You should note that certain technologies and methods for MP3 file recording on CD-Rs prevent optimal playback of these files on your DVD player (degraded sound quality and in some cases, inability of the player to read the files).

- This unit can play a maximum of 500 files and 300 folders per disc.

## Program Play & Random Play

### Program Play (CD/MP3/WMA)

- 1 Press the MODE button.
- 2 Use the ◀, ▶ buttons to select PROGRAM. Press the OK button.



- 3 Use the ▲, ▼ / ◀, ▶ buttons to select the first track to add to the program. Press the OK button. The selection numbers appear in the Program Order box.

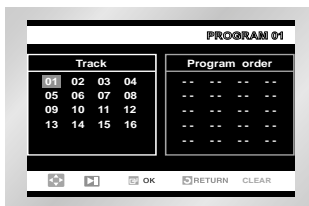

- 4 Press the ▶|| button. The disc will be played in programmed order.

### Random Play (CD/MP3/WMA)

- 1 Press the MODE button.
- 2 Use the ◀, ▶ buttons to select RANDOM. Press the OK button. The disc will be played in random order.



- Depending on the disc, the Program and Random Play functions may not work.
- To resume normal play, press the CLEAR button.
- This unit can support a maximum of 99 programmed order.

## Picture CD Playback

- 1 Open the disc tray.
- 2 Load the disc on the tray. Load the disc with the labeled side up.
- 3 Close the tray.
  - The tray closes and you should get a screen that looks like the one below.
  - Use the ▲, ▼ buttons on the remote controller to select the picture you want to view and then press the OK button.
  - To see the next 6 pictures, press the ▶▶I button.
  - To see the previous 6 pictures, press the I◀◀ button.

- : Return to the Album Screen.
  - : Each time the OK button is pressed, the picture rotates 90 degrees clockwise.
  - : Each time the OK button is pressed, the picture is enlarged up to 4X. (Normal → 2X → 4X → Normal)
  - : The unit enters slide show mode.
- \* Press the RETURN button to return to the album screen.
- \* Before the Slide Show can begin, the picture interval must be set.
- : When this icon is selected and OK is pressed, the pictures change automatically with about a 6 second interval.
  - : The pictures change automatically with about a 12 second interval.
  - : The pictures change automatically with about an 18 second interval.

\* Depending on the file size, each interval between images may take longer or shorter than the manual suggests.



## Picture CD Playback

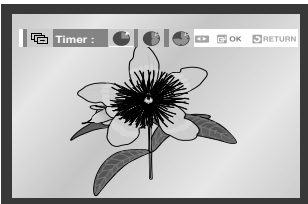
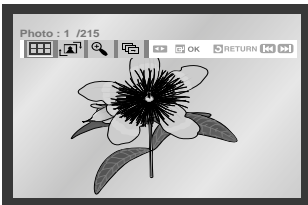
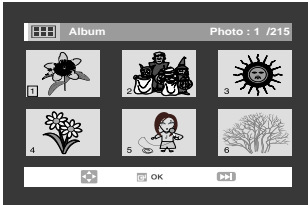
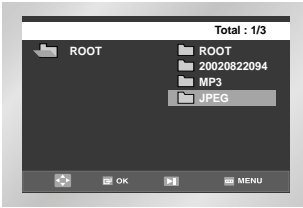

### CD-R JPEG Discs

- Only files with the ".jpg" and ".JPG" extensions can be played.
- If the disc is not closed, it will take longer to start playing and not all of the recorded files may be played.
- Only CD-R discs with JPEG files in ISO 9660 or Joliet format can be played.
- The name of the JPEG file may not be longer than 8 characters and should contain no blank spaces or special characters (. / = +).
- Only a consecutively written multisession disc can be played. If there is a blank segment in the multisession disc, the disc can be played only up to the blank segment.
- A maximum of 500 images can be stored on a single CD.
- Only Kodak Picture CDs can be played.
- When playing a Kodak Picture CD, only the JPEG files in the pictures folder can be played.
- Picture discs other than Kodak Picture CD may take longer to start playing or may not play at all.
- If a number of files in 1 Disc is over 500, only 500 JPEG file can be played.
- If a number of folders in 1 Disc is over 300, only JPEG files in 300 folders can be played.

- • If no buttons on the remote control are pressed for 10 seconds, the menu will disappear. Press the DISC MENU button on the remote control to display the menu again.

## DivX/XviD/MPEG4 Special Playback Features ★(DVD-V540/DVD-V440)

*During DivX/XviD/MPEG4 playback you can select from the following special playback options. To resume normal playback, press the ►II button.*

### 1 Still

Press the ►II button on the remote control during playback.

- The picture will still and the audio will mute.
- To resume playback, press the ►II button.
- If the player is left in Still mode for 5 minutes, it will stop automatically.

### 2 Frame Advance (Step)

While in playback mode, press the F.ADV/STEP button on the remote control to advance one frame at a time.

- Audio is muted during Frame Advance mode.
- Press ►II to resume normal playback.

NOTE: Frame Advance operates only in the forward direction.

### 3 Slow Motion

During playback, press the ►II button to Slow the image. Then use the Search ►► to play in slow motion at variable speeds.

- Each press increases the slow motion speed playback to 1/8, 1/4 or 1/2 normal speed.
- Audio is muted during slow motion playback.

### 4 Stop/Resume

- Press the Stop button once to stop playback. To resume the DivX/XviD/MPEG4 from the point where the disc stopped, press the ►II button.

### 5 Zoom





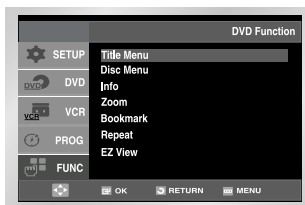

During play, press the MENU button on the remote. Then press the corresponding ▲, ▼ buttons to select the FUNC option.

- Auto Saling : CIF(100kbps)–D1(784kbps) resolution.

If the file resolution is small, it scales up to 2 times automatically. So you can see the more larger screen.



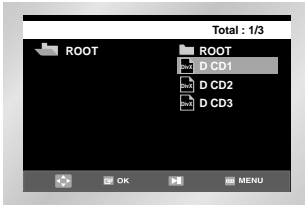

## DivX/XviD/MPEG4 Playback ★ (DVD-V540/DVD-V440)

- When the disc is inserted, the file structure of the disc will be shown. Depending on the file format, a different icon will appear next to each file. The , , and  files will have been highlighted. Use ,  to select the movie file, and then press OK or .   
Result : When the 'Reading Index.....' message is displayed, wait for a second or two. The movie will be played back.



*If the "Codec. Not Supported" message is displayed, the selected file cannot be played back.*

- To navigate to a specific time while viewing the movie, press the INFO. key. The file format of the current file ( , , or  ) and time information will be displayed.
- Use the numeric keys on the remote control to enter the time to jump to that time in the movie.

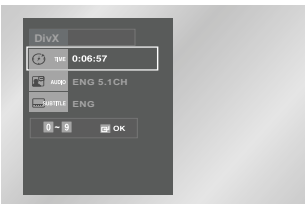

## DivX/XviD/MPEG4 Feature Table

### MPEG4 Supported

Avi files are used to contain the audio and video data; these must be stored on CD in the ISO 9660 format.

		SPEC
VIDEO Compatibility	DivX 3.11 upper	Up to the latest VERSION
	XviD	
	WMV(?)	WMV V1/V2/V3/V7
AUDIO Compatability	MP3	CBR : 80kbps-320kbps
	AC3	CBR : 128kbps-448kbps
	AAC(?)	
	WMA	CBR : 56kbps-160kbps

### MPEGs containing DivX can be divided into Video and Audio.

- Video compatibility : All versions of DivX later than 3.11 (including the latest 5.1) are supported. In addition, XviD is supported. For WMV, V1, V2, V3, and V7 formats are possible.
- Audio compatibility : MP3s encoded at bitrates from 80kbps to 320kbps, AC3s from 128kbps to 448kbps, and WMAs from 56kbps to 160kbps are supported.
- In addition, for subtitles, Samsung will support Text format (SMI).

## Technical Specifications

<b>General</b>	Rated voltage	AC 110 - 240V, 50/60Hz
	Power consumption	19 Watts
	Weight	3.9 Kg
	Size	430mm X 282mm X 82mm
	Operating ambient temperature	+5°C ~ +35°C
	Installation conditions	Operation position : Horizontal, Relative humidity : Below 75%
<b>Input</b>	Video input (Rear)	RCA jack : 1.0Vp-p (unbalanced) 75Ω
	Audio input (Rear)	RCA jack : -8dBm, 47Kohm unbalanced
<b>Output</b>	RF out	UHF 21-69 (Initial CH36)
	Audio (DVD, VCR)	RCA jack
	Audio (DVD only)	Digital audio out (OPTICAL: DVD-V540/DVD-V440), COAXIAL
	Video (DVD, VCR)	RCA jack
	Video (DVD only)	S-Video out COMPONENT out : RCA jack
<b>VCR</b>	Tape format	VHS type video tape, S-VHS type video tape (Playback only)
	Color system	PAL, MESECAM, NT 3.58, NTSC4.43, NTSC playback on PAL TV
	Tuning system	B/G, D/K
	Video S/N	Above 43dB (standard recording)
	Resolution	Above 240 lines (standard recording)
	Audio S/N	Above 68dB (Hi-Fi), 39dB (Mono)
	Audio frequency characteristics	20Hz - 20KHz (Hi-Fi)
<b>DVD</b>	Disc	DVD, CD (12cm), CD (8cm), VIDEO-CD (12cm)
	Audio S/N	95dB
	Audio dynamic range	105dB

## Problems and Solutions (VCR)

Before contacting the Samsung after-sales service, perform the following simple checks.

Problem	Explanation/Solution
No power	<ul style="list-style-type: none"> <li>◆ Check that the power plug is connected to a wall outlet.</li> <li>◆ Have you pressed the STANDBY/ON button?</li> </ul>
You cannot insert a video cassette	<ul style="list-style-type: none"> <li>◆ A video cassette can only be inserted with the window side up and the safety tab facing you.</li> </ul>
The television programme was not recorded	<ul style="list-style-type: none"> <li>◆ Check the DVD-VCR aerial connections.</li> <li>◆ Is the DVD-VCR tuner properly set?</li> <li>◆ Check if the safety tab is intact on the cassette.</li> </ul>
Timer recording was unsuccessful	<ul style="list-style-type: none"> <li>◆ Was the STANDBY/ON button pressed to activate the timer?</li> <li>◆ Re-check the recording start/stop time settings.</li> <li>◆ If there was a power failure or interruption during timer recording, the recording will have been cancelled.</li> </ul>
No playback picture or the picture is distorted	<ul style="list-style-type: none"> <li>◆ Check to see if you are using a prerecorded tape.</li> </ul>
You cannot see normal broadcasts	<ul style="list-style-type: none"> <li>◆ Check the TUNER/EXTERNAL setting. It should be on TUNER.</li> <li>◆ Check the TV/VCR aerial connections.</li> </ul>
Noise bars or streaks on playback	<ul style="list-style-type: none"> <li>◆ Press the TRK (∧ or ∨) buttons to minimize this effect.</li> </ul>
When the ►   button is pressed during playback, the still picture has severe "noise bars" streaks	<ul style="list-style-type: none"> <li>◆ A still picture may have "noise bars", depending on the condition of the tape. Press the TRK (∧ or ∨) buttons during SLOW motion to minimize this effect.</li> </ul>
Video Head Cleaning	<ul style="list-style-type: none"> <li>◆ If poor pictures appear on a variety of cassettes, the video heads may need cleaning. This is not a common problem and unless it appears, the heads should not be cleaned. When cleaning the video heads, read all instructions provided with the head cleaning cassette. Incorrect head cleaning can permanently damage the video heads.</li> </ul>
If when tuning in your TV to the DVD-VCR TV does not find the Screen or the pattern when found suffers from interference, it may be due to the DVD-VCR output channel clashing with the normal TV transmissions in your area. To prevent this you will need to change the DVD-VCR output channel in the following way	<ol style="list-style-type: none"> <li>1. Remove the aerial input plug from the socket marked (aerial symbol) on the rear of the DVD-VCR.</li> <li>2. Carry out the instructions "Tuning Your Television for the DVD-VCR" (see page 9).</li> <li>3. Carry out the instructions "Setting the DVD-VCR output Channel" (see page 15), move the channel number several channels down from the original setting. (example: from 36 to 37).</li> <li>4. Replace the aerial plug into the socket marked (aerial symbol) on the rear of the DVD-VCR.</li> <li>5. Re-tune your TV to the DVD-VCR again by following instructions "Tuning Your Television for the DVD-VCR" (page 9).</li> <li>6. If the problem still exists repeat steps 1 to 5 moving several more channels away from the original setting.</li> </ol>

If you are unable to solve the problem after reading the above instructions, note:

- ◆ The model and serial number on the rear of your DVD-VCR
- ◆ The warranty information
- ◆ A clear description of the problem

Then contact your nearest SAMSUNG after-sales service.

## Troubleshooting Guide (DVD)

### Before requesting service (troubleshooting)

Problem	Action	Page
Disc does not play.	<ul style="list-style-type: none"> <li>◆ Ensure that the disc is installed with the label side facing up.</li> <li>◆ Check the region number of the DVD.</li> <li>◆ This player cannot play CD-ROMs, DVD-ROMs, etc. Insert a DVD, a VIDEO-CD or a CD.</li> </ul>	P4
5.1 channel sound is not being reproduced.	<ul style="list-style-type: none"> <li>◆ 5.1 channel sound is reproduced only when the following conditions are met. :               <ol style="list-style-type: none"> <li>1) The DVD-VCR player is connected with the proper amplifier</li> <li>2) The disc is recorded with 5.1 channel sound.</li> </ol> </li> <li>◆ Check whether the disc being played has the "Dolby 5.1 ch" mark on the outside.</li> <li>◆ Check if your audio system is connected and working properly.</li> </ul>	P28
The  icon appears on screen.	<ul style="list-style-type: none"> <li>◆ The features or action cannot be completed at this time because:               <ol style="list-style-type: none"> <li>1. The DVD's software restricts it.</li> <li>2. The DVD's software doesn't support the feature (e.g., angles).</li> <li>3. The feature is not available at the moment.</li> <li>4. You've requested a title or chapter number or search time that is out of range.</li> </ol> </li> </ul>	P31-39
Playback mode differs from the Setup Menu selection.	<ul style="list-style-type: none"> <li>◆ Some of the functions selected in the Setup Menu may not work properly if the disc is not encoded with the corresponding function.</li> </ul>	P26-30
The screen ratio cannot be changed.	<ul style="list-style-type: none"> <li>◆ The Screen Ratio is fixed on your DVDs.</li> </ul>	P29
No audio.	<ul style="list-style-type: none"> <li>◆ Make sure you have selected the correct Digital Output in the Audio Options Menu.</li> </ul>	P28
Forgot password	<ul style="list-style-type: none"> <li>◆ Press STANDBY/ON from a cold start with no disc in the unit. Press the ◀ and ▶ buttons simultaneously on the front panel for five seconds. Switch off and on the DVD-VCR by pressing STANDBY/ON button. The Parental Mode is now unlocked as indicated on the display. You can now set your rating level and change your password to a new number.</li> </ul>	
If you experience other problems.	<ul style="list-style-type: none"> <li>◆ Go to the contents and find the section of the instruction book that contains the explanations regarding the current problem, and follow the procedure once again.</li> <li>◆ If the problem still cannot be solved, please contact your nearest authorized service center.</li> </ul>	

**THIS APPLIANCE IS DISTRIBUTED BY**

